

CHIMEI INNOLUX DISPLAY CORPORATION

LCD MODULE SPECIFICATION

Customer: _____
Model Name: HJ070IA-02F
Date: 2012/12/20
Version: V01

- Preliminary Specification
 Final Specification

For Customer's Acceptance

Approved by	Comment

Approved by	Reviewed by	Prepared by
Stanley CW Leung	Green Fu	Sunny Sun

CHIMEI InnoLux copyright
2012
All rights reserved,
Copying forbidden.

Record of Revision

Version	Revise Date	Page	Content
V01	2012/12/20	all	Initial Release.

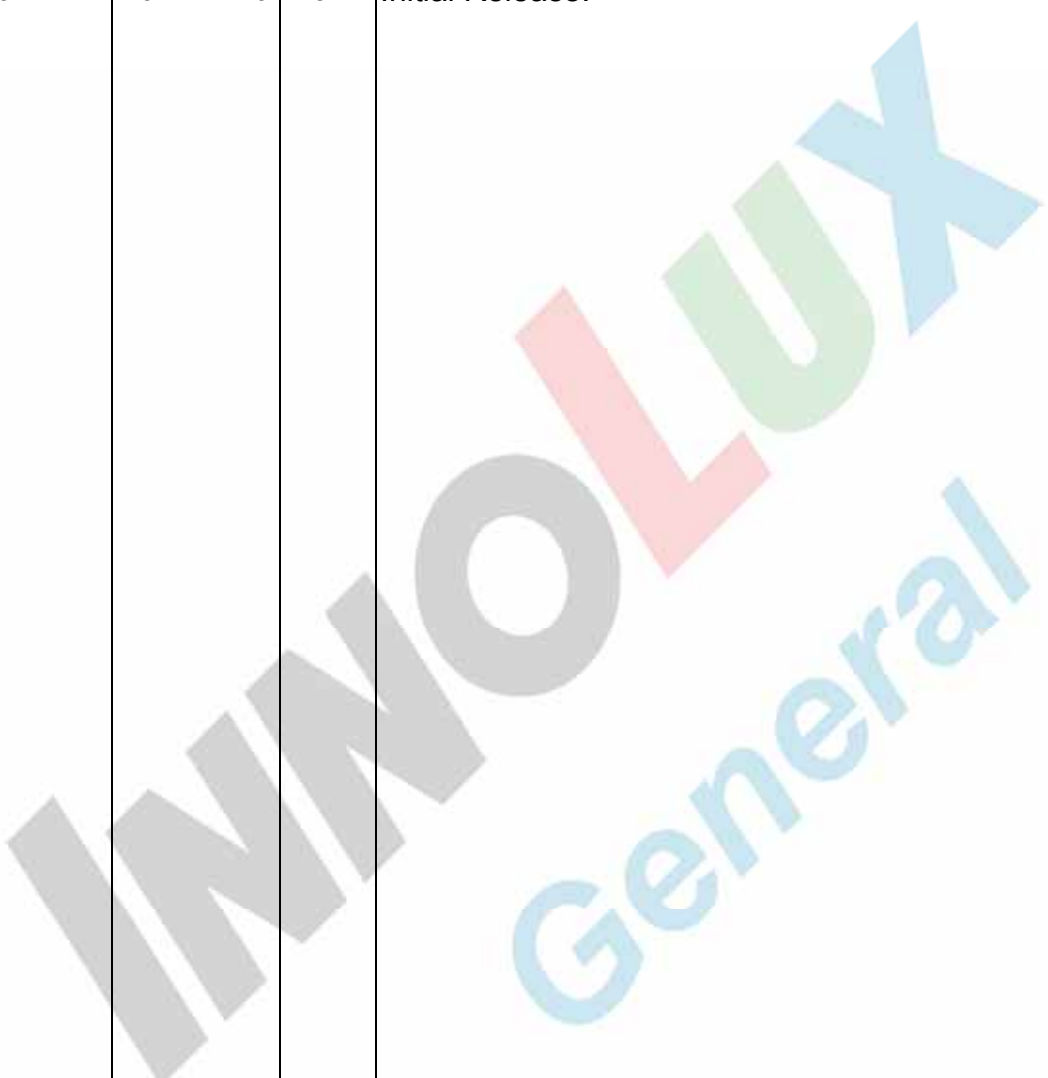

Contents

1. GENERAL Specifications	1
2.Pin Assignment	2
3.Operation Specifications	4
3.1. Absolute Maximum Ratings	4
3.1.1. Typical Operation Conditions.....	5
3.1.2. Current Consumption	6
3.1.3. Backlight Driving Conditions.....	6
3.2. Power Sequence	7
3.3. Timing Characteristics	8
3.3.1. DC Electrical Characteristics	8
3.3.2. Timing.....	9
3.3.3. Data Input Format	10
4. Optical Specifications	11
5. Reliability Test Items	15
6. General Precautions	16
6.1. Safety	16
6.2. Handling	16
6.3. Static Electricity.....	16
6.4. Storage	16
6.5. Cleaning	16
7. Mechanical Drawing.....	17
8. Package Drawing.....	18
8.1. Packaging Material Table.....	18
8.2. Packaging Quantity.....	18
8.3. Packaging Drawing.....	19

1. GENERAL Specifications

No.	Item	Specification	Remark
1	LCD size	7"	
2	Driver element	a-Si TFT active matrix	
3	Resolution	1280 × 3(RGB) × 800	
4	Display mode	Normally Black, Transmissive	
5	Dot pitch	0.039 (W) × 0.117 (H)	
6	Active area	149.76(H) × 93.6(V)	
7	Module size	161.2(H) × 107.2(V) × 2.5(T)	Note 1
8	Surface treatment	Hard coating	
9	Color arrangement	RGB-stripe	
10	Interface	LVDS	
11	Backlight power consumption	TBD	
12	Panel power consumption	0.81W(Typ.)	
13	Weight	TBD	

Note 1: Refer to Mechanical Drawing.

2.Pin Assignment

FPC Connector is used for the module electronics interface. The model is F62240-H1210A manufactured by Vigorconn.

Pin No.	Symbol	I/O	Function	Remark
1	VCOM	P	Common Voltage	
2	VDD	P	Power Voltage for digital circuit	
3	VDD	P	Power Voltage for digital circuit	
4	NC	---	No connection	
5	NC	---	No connection	
6	NC	---	No connection	
7	GND	P	Ground	
8	RXIN0-	I	- LVDS differential data input	
9	RXIN0+	I	+ LVDS differential data input	
10	GND	P	Ground	
11	RXIN1-	I	- LVDS differential data input	
12	RXIN1+	I	+ LVDS differential data input	
13	GND	P	Ground	
14	RXIN2-	I	- LVDS differential data input	
15	RXIN2+	I	+ LVDS differential data input	
16	GND	P	Ground	
17	RXCLKIN-	I	- LVDS differential clock input	
18	RXCLKIN+	I	+ LVDS differential clock input	
19	GND	P	Ground	
20	RXIN3-	I	- LVDS differential data input	
21	RXIN3+	I	+ LVDS differential data input	
22	GND	P	Ground	
23	NC	---	No connection	
24	NC	---	No connection	
25	GND	P	Ground	
26	NC	---	No connection	

27	NC	---	No connection	
28	NC	---	No connection	
29	AVDD	P	Power for Analog Circuit	
30	GND	P	Ground	
31	LED-	P	LED Cathode	
32	LED-	P	LED Cathode	
33	NC	---	No connection	
34	NC	---	No connection	
35	VGL	P	Gate OFF Voltage	
36	NC	---	No connection	
37	NC	---	No connection	
38	VGH	P	Gate ON Voltage	
39	LED+	P	LED Anode	
40	LED+	P	LED Anode	

I: input, O: output, P: Power

Note: Definition of scanning direction.
Refer to the figure as below:

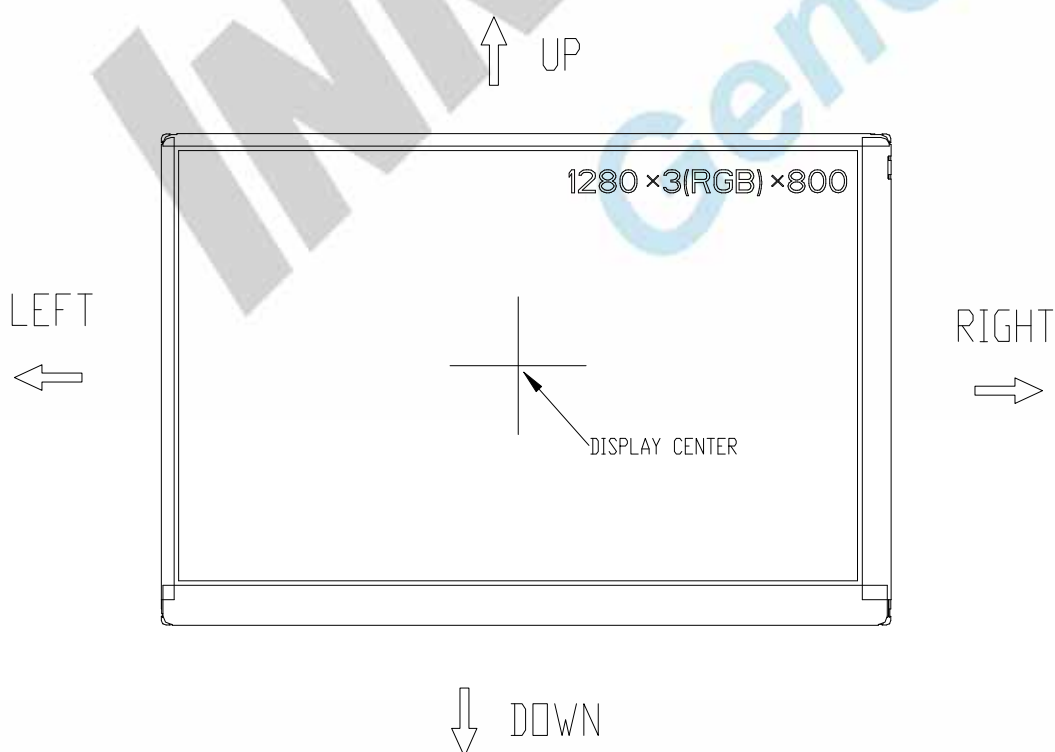

版權屬於群創所有, 禁止任何未經授權的使用

The copyright belongs to Chimei InnoLux. Any unauthorized use is prohibited.

3.Operation Specifications

3.1. Absolute Maximum Ratings

(Note 1)

Item	Symbol	Values		Unit	Remark
		Min.	Max.		
Power voltage	V_{DD}	-0.3	5.0	V	
	AV_{DD}	-0.5	15	V	
	V_{GH}	-0.3	40	V	
	V_{GL}	-20.0	0.3	V	
	$V_{GH}-V_{GL}$	-0.3	40.0	V	
Operation Temperature	T_{OP}	-10	50	°C	
Storage Temperature	T_{ST}	-20	60	°C	
LED Reverse Voltage	V_R	-	-	V	Each LED
LED Forward Current	I_F	-	-	mA	Each LED

Note 1: The absolute maximum rating values of this product are not allowed to be exceeded at any times. Should a module be used with any of the absolute maximum ratings exceeded, the characteristics of the module may not be recovered, or in an extreme case, the module may be permanently destroyed.

3.1.1. Typical Operation Conditions

(Note 1)

Item	Symbol	Values			Unit	Remark
		Min.	Typ.	Max.		
Power voltage	V _{DD}	3.1	3.3	3.5	V	Note 2
	AV _{DD}	9.54	9.74	9.94	V	
	V _{GH}	22.4	22.7	23	V	
	V _{GL}	-7.7	-8	-8.3	V	
Input signal voltage	V _{COM}	3.0	3.3	3.6	V	Note 4
Input logic high voltage	V _{IH}	0.7V _{DD}	-	V _{DD}	V	Note 3
Input logic low voltage	V _{IL}	0	-	0.3V _{DD}	V	

Note 1: Be sure to apply V_{DD} and V_{GL} to the LCD first, and then apply V_{GH}.

Note 2: V_{DD} setting should match the signals output voltage (refer to Note 3) of customer's system board.

Note 4: Typical V_{COM} is only a reference value, it must be optimized according to each LCM. Be sure to use VR.

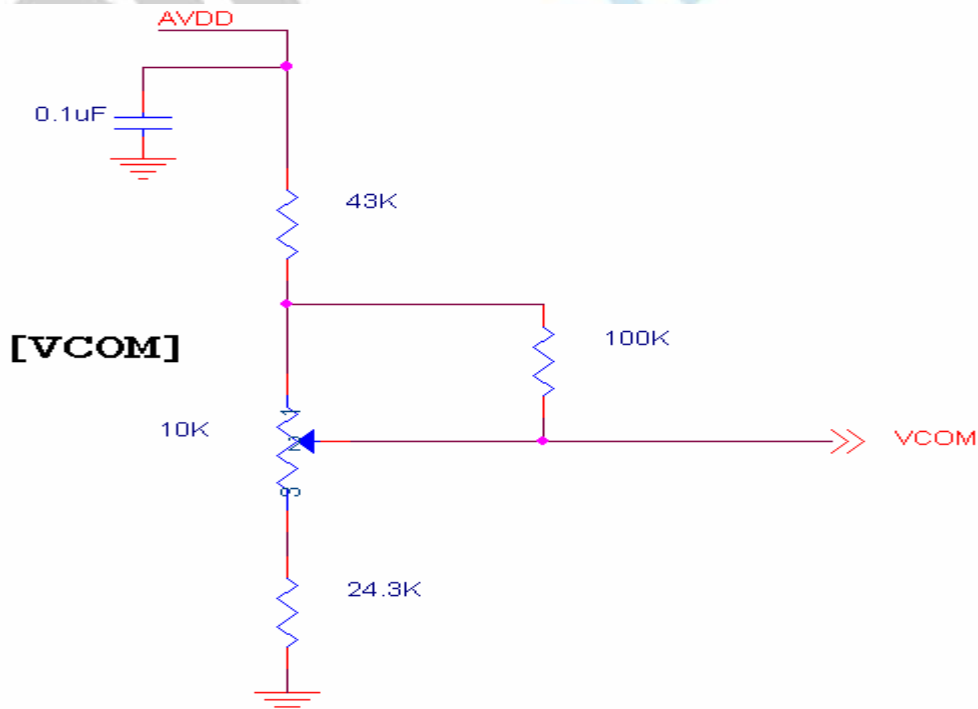

版權屬於群創所有, 禁止任何未經授權的使用

3.1.2. Current Consumption

Item	Symbol	Values			Unit	Remark
		Min.	Typ.	Max.		
Current for Driver	I_{GH}	-	0.5	1	mA	$V_{GH} = 22.7V$
	I_{GL}	-	0.5	1	mA	$V_{GL} = -8V$
	$I_{V_{DD}}$	-	135	150	mA	$V_{DD} = 3.3V$
	$I_{AV_{DD}}$	-	35	60	mA	$AV_{DD} = 9.74V$

3.1.3. Backlight Driving Conditions

Item	Symbol	Values			Unit	Remark
		Min.	Typ.	Max.		
Voltage for LED backlight	V_L	-	12.8	13.2	V	Note 1
Current for LED backlight	I_L	96	100	104	mA	
LED life time	-	15000	-	-	Hr	Note 2

Note 1: The LED Supply Voltage is defined by the number of LED at $T_a = 25^\circ C$ and $I_L = 100mA$.

Note 2: The "LED life time" is defined as the module brightness decrease to 50% original brightness at $T_a = 25^\circ C$ and $I_L = 100mA$. The LED lifetime could be decreased if operating I_L is larger than 100mA.

3.2. Power Sequence

a. Power on:

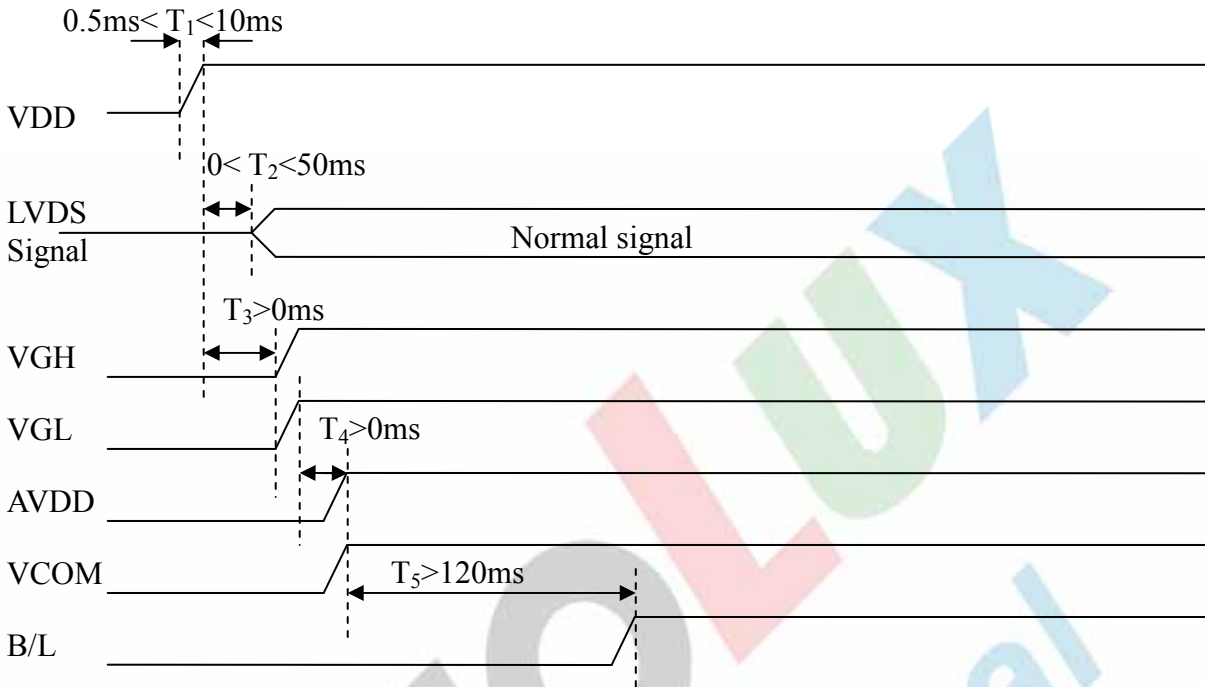

b. Power off:

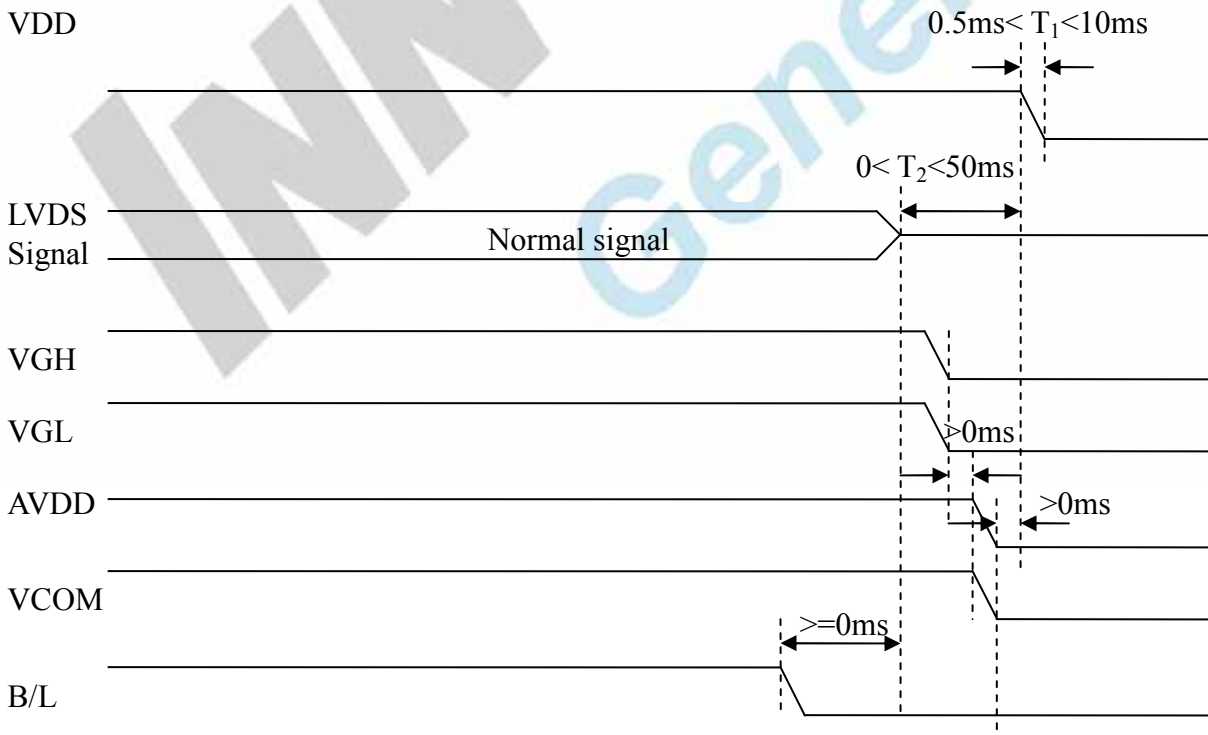

版權屬於群創所有, 禁止任何未經授權的使用

The copyright belongs to Chimei InnoLux. Any unauthorized use is prohibited.

3.3. Timing Characteristics

3.3.1. DC Electrical Characteristics

Parameter	Symbol	Values			Unit	Remark
		Min.	Typ.	Max.		
Differential input high Threshold voltage	R_{xVTH}	-	-	+0.1	V	$R_{xVCM}=1.2V$
Differential input low Threshold voltage	R_{xVTL}	-0.1	-	-	V	
Differential input common mode voltage	R_{xVCM}	1.125	-	1.375	V	
Differential voltage	$ V_{ID} $	0.2	-	0.6	V	

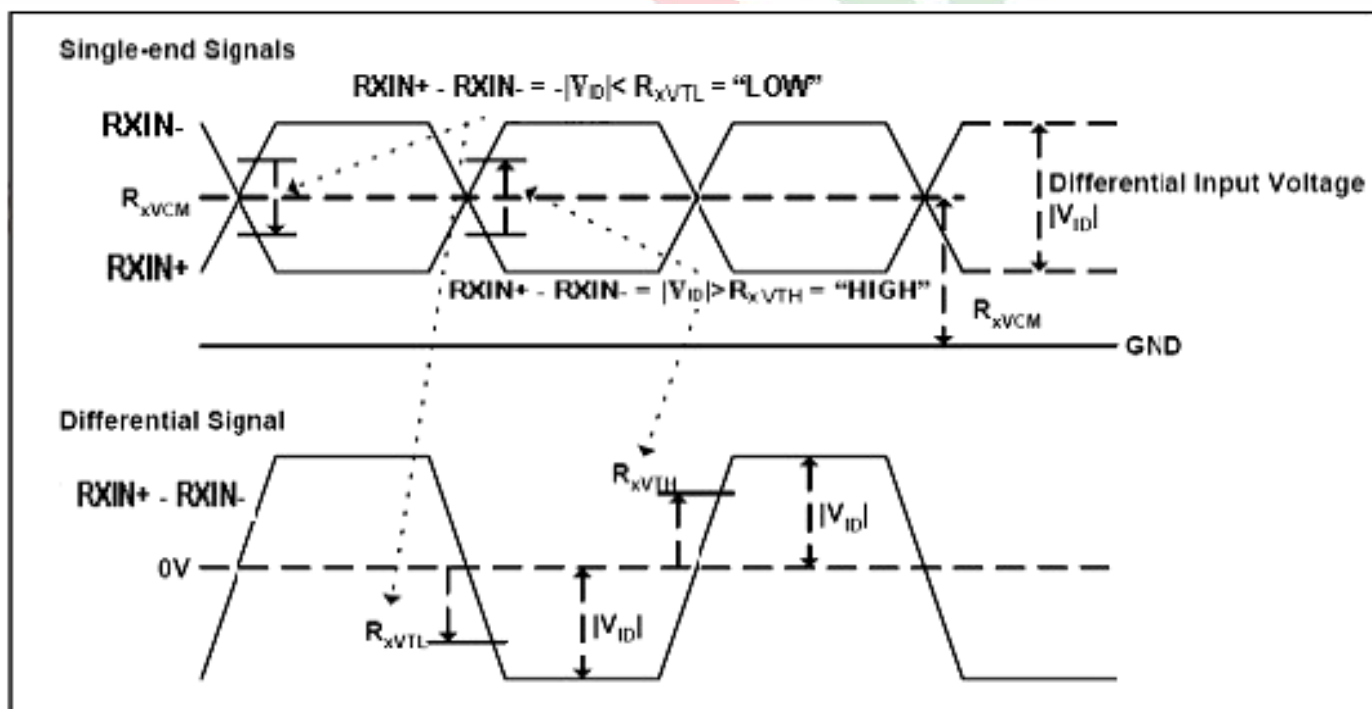

版權屬於群創所有, 禁止任何未經授權的使用

The copyright belongs to Chimei InnoLux. Any unauthorized use is prohibited.

3.3.2. Timing

Item	Symbol	Values			Unit	Remark
		Min.	Typ.	Max.		
Clock Frequency	fclk	(67.55)	(71.11)	(78.22)	MHz	Frame rate =60Hz
Horizontal display area	thd	1280				
HS period time	th	(1410)	(1440)	(1470)	DCLK	
HS Blanking	thb	130	160	190	DCLK	
Vertical display area	tvd	800				
VS period time	tv	(813)	(823)	(833)	H	
VS Blanking	thb	13	23	33	H	

3.3.3. Data Input Format

8bit LVDS input

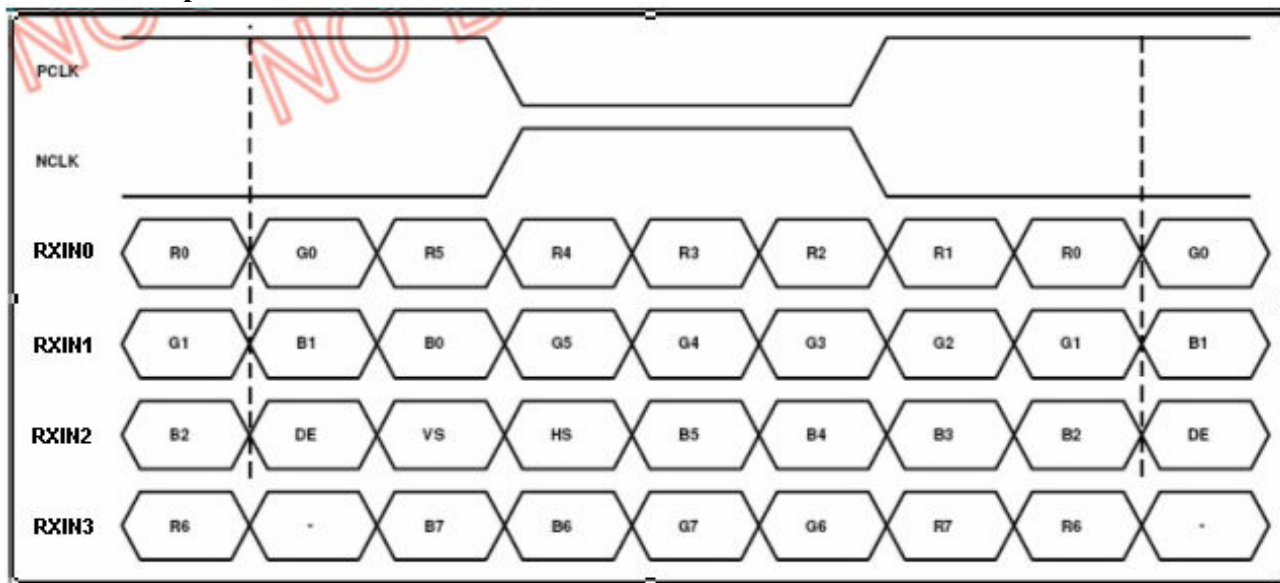

INNOLUX
General

4. Optical Specifications

Item	Symbol	Condition	Values			Unit	Remark
			Min.	Typ.	Max.		
Viewing angle (CR \geq 10)	θ_L	$\Phi=180^\circ$ (9 o'clock)	80	89	-	degree	Note 1
	θ_R	$\Phi=0^\circ$ (3 o'clock)	80	89	-		
	θ_T	$\Phi=90^\circ$ (12 o'clock)	80	89	-		
	θ_B	$\Phi=270^\circ$ (6 o'clock)	80	89	-		
Response time	T_{ON}	Normal $\theta=\Phi=0^\circ$	-	15	20	msec	Note 3
	T_{OFF}		-	20	30	msec	Note 3
Contrast ratio	CR		600	800	-	-	Note 4
Color chromaticity	W_X		0.26	0.31	0.36	-	Note 2 Note 5
	W_Y		0.28	0.33	0.38	-	Note 6
Luminance	L		270	350	-	cd/m ²	Note 6
Luminance uniformity	Y_U		70	75	-	%	Note 7

Test Conditions:

1. VDD=3.3V, IL=100mA (Backlight current), the ambient temperature is 25°C.
2. The test systems refer to Note 2.

Note 1: Definition of viewing angle range

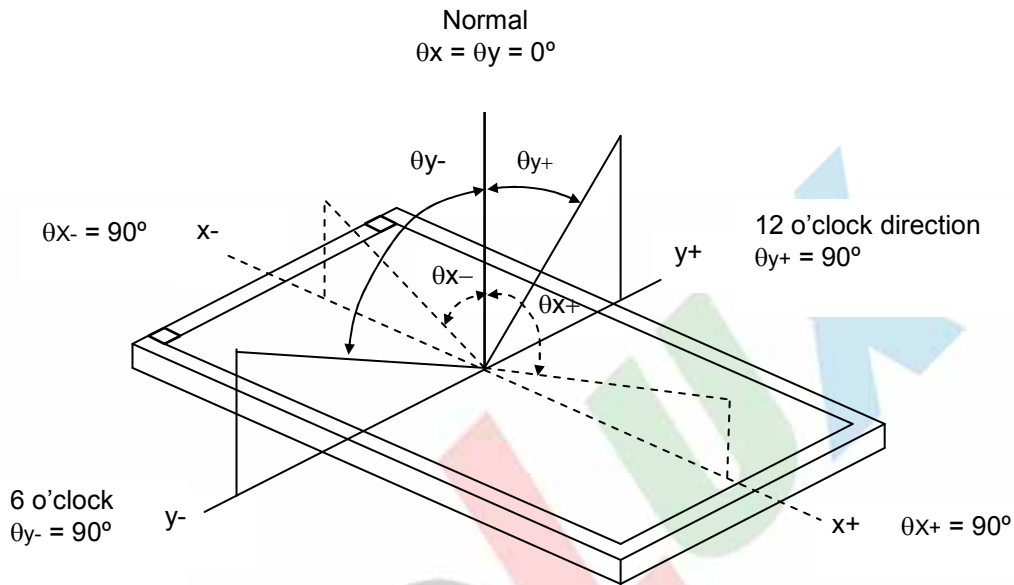

Note 2: Definition of optical measurement system.

The optical characteristics should be measured in dark room. After 30 minutes operation, the optical properties are measured at the center point of the LCD screen. (Response time is measured by Photo detector TOPCON BM-7, other items are measured by BM-5A/Field of view: 1° /Height: 500mm.)

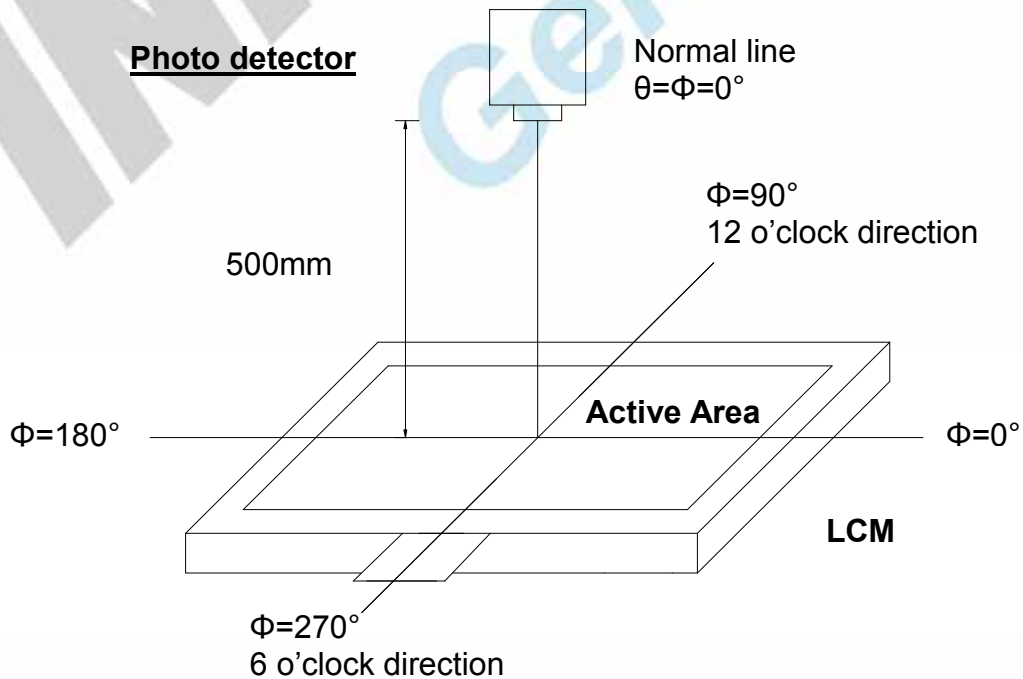

版權屬於群創所有, 禁止任何未經授權的使用

Fig. 4-2 Optical measurement system setup

Note 3: Definition of Response time

The response time is defined as the LCD optical switching time interval between "White" state and "Black" state. Rise time (T_{ON}) is the time between photo detector output intensity changed from 90% to 10%. And fall time (T_{OFF}) is the time between photo detector output intensity changed from 10% to 90%.

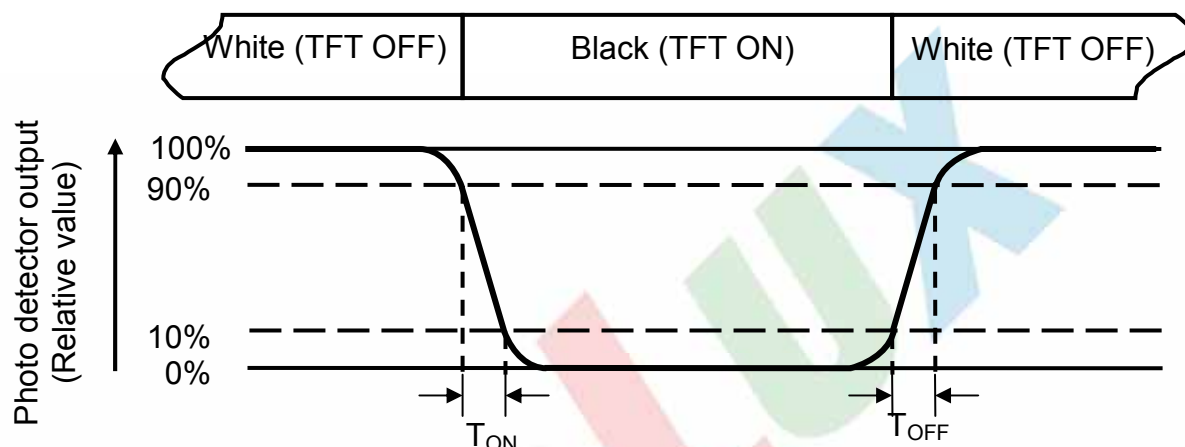

Fig. 4-3 Definition of response time

Note 4: Definition of contrast ratio

$$\text{Contrast ratio (CR)} = \frac{\text{Luminance measured when LCD on the "White" state}}{\text{Luminance measured when LCD on the "Black" state}}$$

Note 5: Definition of color chromaticity (CIE1931)

Color coordinates measured at center point of LCD.

Note 6: All input terminals LCD panel must be ground while measuring the center area of the panel. The LED driving condition is $I_L=160\text{mA}$.

Note 7: Definition of Luminance Uniformity

Active area is divided into 9 measuring areas (Refer to Fig. 4-4).Every measuring point is placed at the center of each measuring area.

$$\text{Luminance Uniformity (Yu)} = \frac{B_{min}}{B_{max}}$$

L-----Active area length W----- Active area width

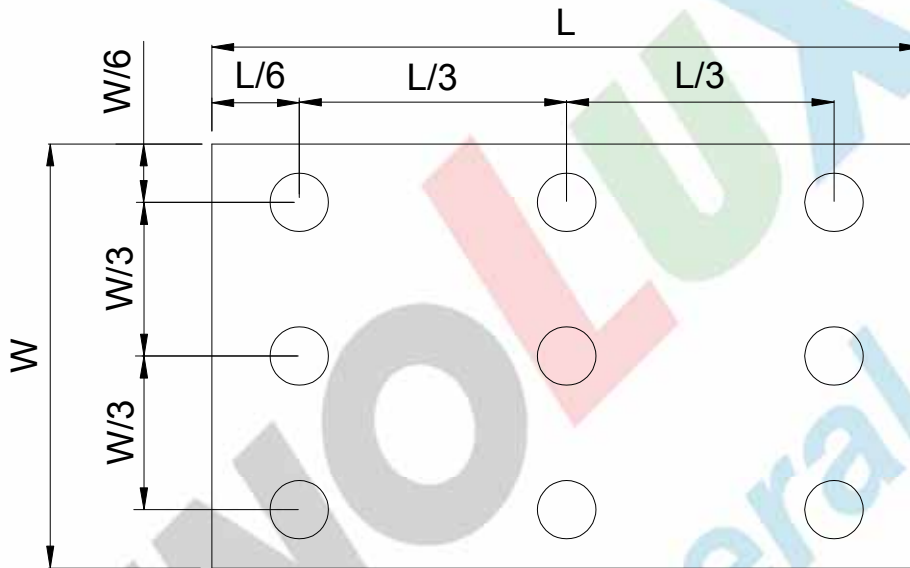

Fig. 4-4 Definition of measuring points

B_{max}: The measured maximum luminance of all measurement position.

B_{min}: The measured minimum luminance of all measurement position.

5. Reliability Test Items

(Note3)

Item	Test Conditions	Remark
High Temperature Storage	Ta = 60°C 120hrs	Note 1, Note 4
Low Temperature Storage	Ta = -20°C 120hrs	Note 1, Note 4
High Temperature Operation	Ts = 50°C 120hrs	Note 2, Note 4
Low Temperature Operation	Ta = -10°C 120hrs	Note 1, Note 4
Operate at High Temperature and Humidity	+40°C, 90%RH 120hrs	Note 4
Thermal Shock	-10°C/30 min ~ +60°C/30 min for a total 100 cycles, Start with cold temperature and end with high temperature.	Note 4
Vibration Test	Frequency range:10~55Hz Stroke:1.5mm Sweep:10Hz~55Hz~10Hz 2 hours for each direction of X. Y. Z. (6 hours for total)	
Mechanical Shock	100G 6ms,±X, ±Y, ±Z 3 times for each direction	
Package Vibration Test	Random Vibration : ISTA-3A 1Hz~200Hz,Grms=0.53 Half hours for direction of Z.	
Package Drop Test	Height:60 cm 1 corner, 3 edges, 6 surfaces	
Electro Static Discharge	± 2KV, Human Body Mode, 100pF/1500Ω	

Note 1: Ta is the ambient temperature of samples.

Note 2: Ts is the temperature of panel's surface.

Note 3: In the standard condition, there shall be no practical problem that may affect the display function. After the reliability test, the product only guarantees operation, but don't guarantee all of the cosmetic specification.

Note 4: Before cosmetic and function test, the product must have enough recovery time, at least 2 hours at room temperature.

6. General Precautions

6.1. Safety

Liquid crystal is poisonous. Do not put it in your mouth. If liquid crystal touches your skin or clothes, wash it off immediately by using soap and water.

6.2. Handling

1. The LCD panel is plate glass. Do not subject the panel to mechanical shock or to excessive force on its surface.
2. The polarizer attached to the display is easily damaged. Please handle it carefully to avoid scratch or other damages.
3. To avoid contamination on the display surface, do not touch the module surface with bare hands.
4. Keep a space so that the LCD panels do not touch other components.
5. Put cover board such as acrylic board on the surface of LCD panel to protect panel from damages.
6. Transparent electrodes may be disconnected if you use the LCD panel under environmental conditions where the condensation of dew occurs.
7. Do not leave module in direct sunlight to avoid malfunction of the ICs.

6.3. Static Electricity

1. Be sure to ground module before turning on power or operating module.
2. Do not apply voltage which exceeds the absolute maximum rating value.

6.4. Storage

1. Store the module in a dark room where must keep at $25\pm 10^{\circ}\text{C}$ and 65%RH or less.
2. Do not store the module in surroundings containing organic solvent or corrosive gas.
3. Store the module in an anti-electrostatic container or bag.

6.5. Cleaning

1. Do not wipe the polarizer with dry cloth. It might cause scratch.
2. Only use a soft sloth with IPA to wipe the polarizer, other chemicals might permanent damage to the polarizer.

7. Mechanical Drawing

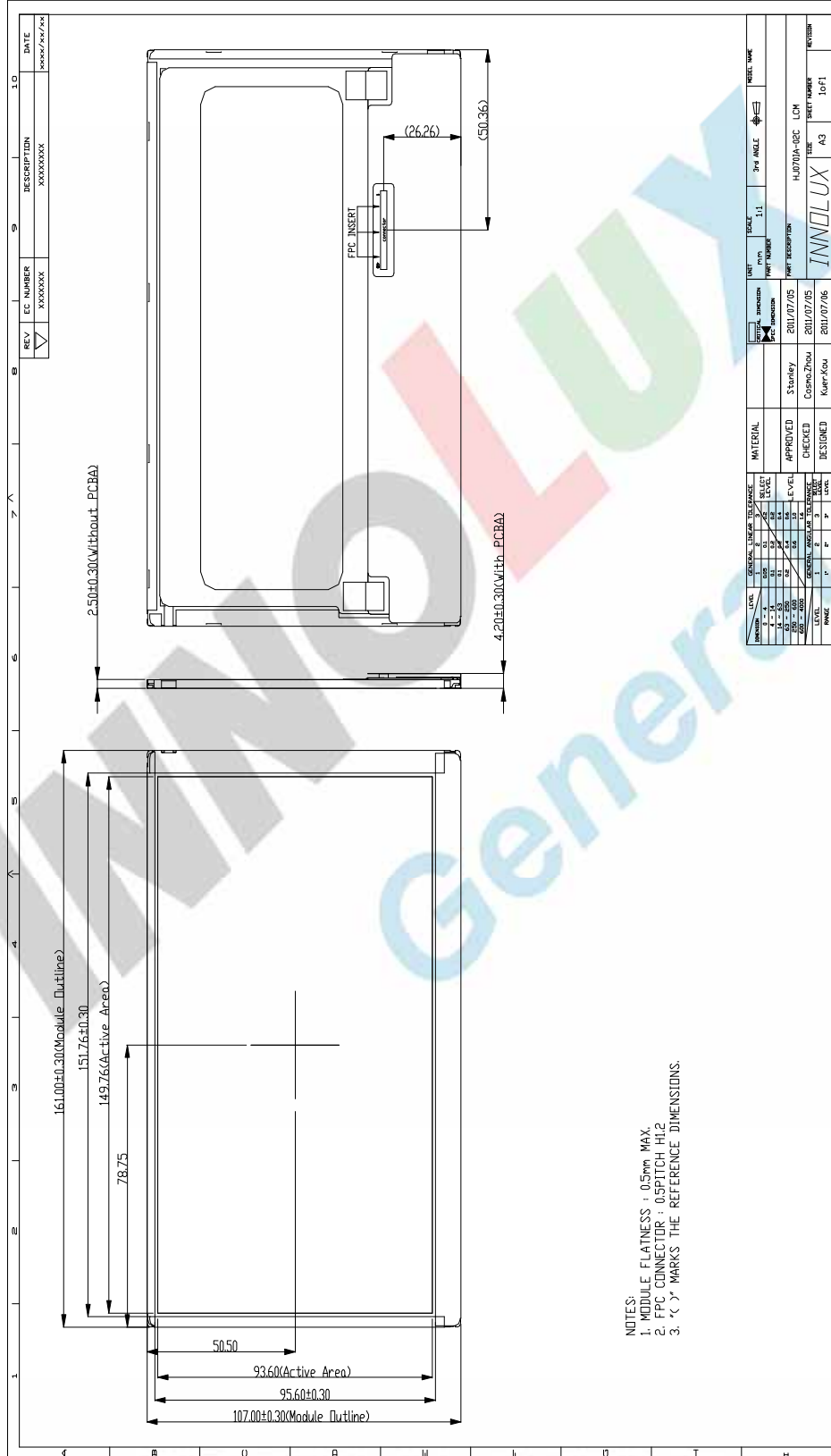

NOTES:
 1. MODULE FLATNESS : 0.5mm MAX.
 2. FPC CONNECTOR : 0.5PITCH H1.2
 3. (< >) MARKS THE REFERENCE DIMENSIONS.

版權屬於群創所有，禁止任何未經授權的使用

8. Package Drawing

8.1. Packaging Material Table

No.	Item	Model (Material)	Dimensions(mm)	Unit Weight (kg)	Quantity	Remark
1	LCM Module	HJ070IA-02F	161.2×107.2×2.5	TBD	TBD	
2	Partition	BC Corrugated paper	TBD	TBD	TBD	
3	Corrugated Paper	B Corrugated paper	TBD	TBD	TBD	
4	Corrugated Bar	B Corrugated paper	TBD	TBD	TBD	
5	Dust-Proof Bag	PE	TBD	TBD	TBD	
6	A/S Bag	PE	TBD	TBD	TBD	
7	Carton	Corrugated paper	TBD	TBD	TBD	
8	Total weight	TBD				

8.2. Packaging Quantity

Total LCM quantity in Carton: 4PCS/Tray x 20PCS Tray/carton=80PCS

8.3. Packaging Drawing

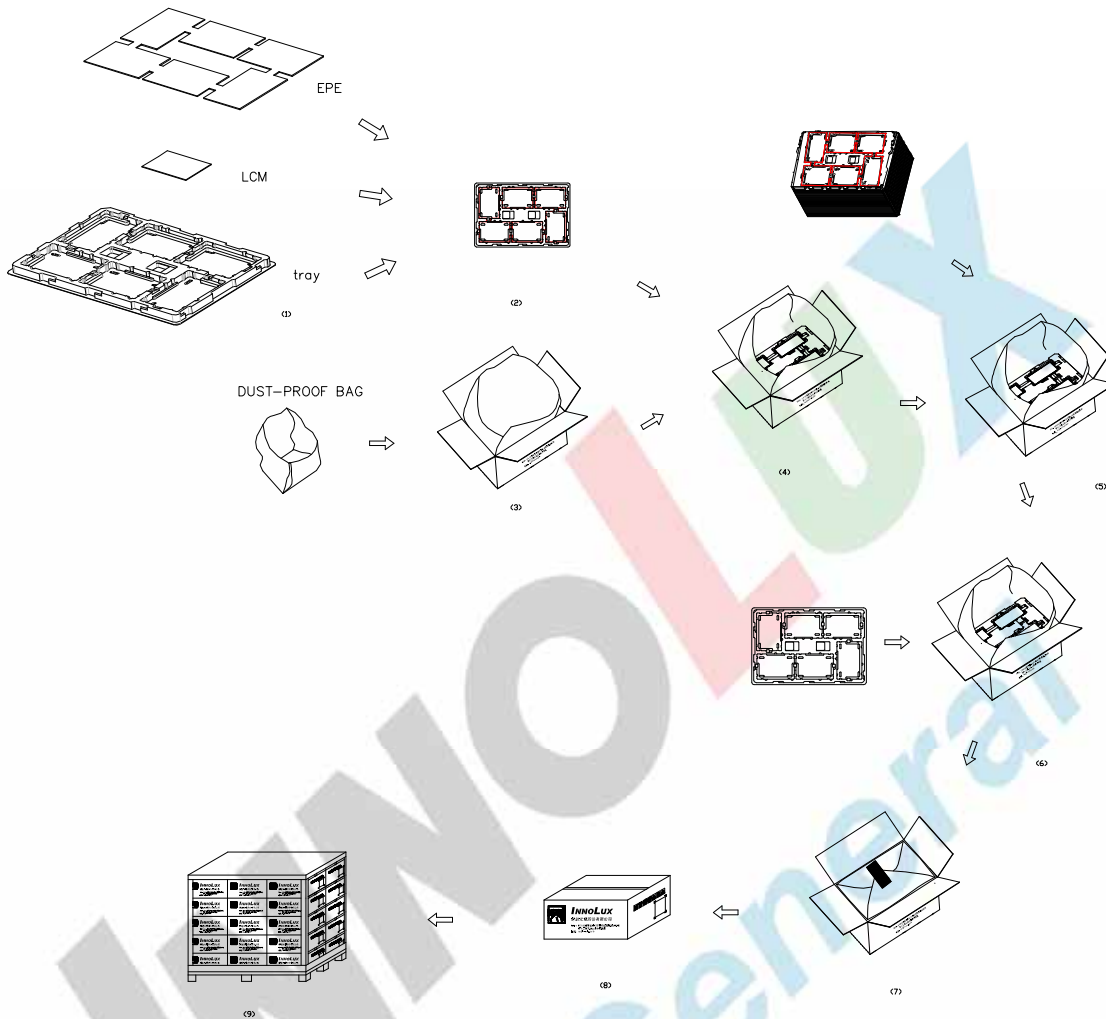

版權屬於群創所有, 禁止任何未經授權的使用

The copyright belongs to Chimei InnoLux. Any unauthorized use is prohibited.