

INNOLUX DISPLAY CORPORATION

LCD MODULE

SPECIFICATION

Customer: _____
Model Name: AT102TN03 V.9
SPEC NO.: A102-03-TT-91
Date: 2009/03/26
Version: 01

- Preliminary Specification
- Final Specification

For Customer's Acceptance

Approved by	Comment

Approved by	Reviewed by	Prepared by
Joe Lin 2009/03/30	James Yu Jack Huang Charlie Chou 2009/03/30	David Lee 2009/03/26

The copyright belongs to InnoLux. Any unauthorized use is prohibited.

InnoLux copyright 2004
All rights reserved,
Copying forbidden.

Record of Revision

Version	Revise Date	Page	Content
Pre-SPEC 01	2009/03/26		Initial Release

版權屬於群創所有，禁止任何未經授權的使用

The copyright belongs to InnoLux. Any unauthorized use is prohibited.

Contents:

1. General Specifications	1
2. Pin Assignment	2
2.1. TFT LCD Panel Driving Section	2
2.2. Backlight Unit Section	5
3. Operation Specifications	6
3.1. Absolute Maximum Rating	6
3.1.1 Typical Operation Conditions	7
3.1.2 Current Consumption	8
3.1.3 Backlight Driving Conditions	8
3.2 Power Sequence	9
3.3 Timing Characteristics	10
3.3.1 Timing Conditions	10
3.3.2 Timing Diagram	11
4. Optical Specifications	18
5. Reliability Test Items	22
6. General Precautions	23
6.1 Safety	23
6.2 Handling	23
6.3 Static Electricity	23
6.4 Storage	23
6.5 Cleaning	23
7 Mechanical Drawing	24
8 Package Drawing	25
8.1 Packaging Material Table	25
8.2 Packaging Quantity	25
8.3 Packaging Drawing	26

1. General Specifications

No.	Item	Specification	Remark
1	LCD size	10.2 inch(Diagonal)	
2	Driver element	a-Si TFT active matrix	
3	Resolution	800 × 3(RGB) × 480	
4	Display mode	Normally white, Transmissive	
5	Dot pitch	0.0925(W) × 0.276(H) mm	
6	Active area	222.0(W) × 132.48(H) mm	
7	Module size	235.0(W) × 145.8(H) × 6.1(D) mm	Note 1
8	Surface treatment	Anti-Glare	
9	Color arrangement	RGB-stripe	
10	Interface	Digital	
11	Backlight power consumption	1.86W(Typ.)	
12	Panel power consumption	0.25W(Typ.)	
13	Weight	TBD	

Note 1: Refer to Mechanical Drawing.

2. Pin Assignment

2.1. TFT LCD Panel Driving Section

FPC connector is used for the module electronics interface. The recommended model is "AF 730L-A2G1T" manufactured by P-TWO.

Pin No.	Symbol	I/O	Function	Remark
1	POL	I	Polarity selection	
2	STVD	I/O	Vertical start pulse input when U/D= H	Note 1
3	OEV	I	Output enable	
4	CKV	I	Vertical clock	
5	STVU	I/O	Vertical start pulse input when U/D= L	Note 1
6	GND	P	Power ground	
7	EDGSL	I	Select rising edge or rising/falling edge	
8	V _{CC}	P	Power supply for digital circuit	
9	V ₉	I	Gamma voltage level 9	
10	V _{GL}	P	Gate OFF voltage	
11	V ₂	I	Gamma voltage level 2	
12	V _{GH}	P	Gate ON voltage	
13	V ₆	I	Gamma voltage level 6	
14	U/D	I	Up/down selection	Note 1,2
15	V _{COM}	I	Common voltage	
16	GND	P	Power ground	
17	AV _{DD}	P	Power supply for analog circuit	
18	V ₁₄	I	Gamma voltage level 14	
19	V ₁₁	I	Gamma voltage level 11	
20	V ₈	I	Gamma voltage level 8	
21	V ₅	I	Gamma voltage level 5	
22	V ₃	I	Gamma voltage level 3	
23	GND	P	Power ground	
24	R ₅	I	Red data(MSB)	
25	R ₄	I	Red data	
26	R ₃	I	Red data	
27	R ₂	I	Red data	
28	R ₁	I	Red data	

29	R0	I	Red data(LSB)	
30	GND	P	Power ground	
31	GND	P	Power ground	
32	G5	I	Green data(MSB)	
33	G4	I	Green data	
34	G3	I	Green data	
35	G2	I	Green data	
36	G1	I	Green data	
37	G0	I	Green data(LSB)	
38	STHL	I/O	Horizontal start pulse input when R/L = L	Note 1
39	REV	P	Control signal are inverted or not	Note 3
40	GND	I	Power ground	
41	DCLK	I	Sample clock	
42	V _{CC}	P	Power supply for digital circuit	
43	STHR	I/O	Horizontal start pulse input when R/L = H	Note 1
44	LD	I	Latches the polarity of outputs and switches the new data to outputs	
45	B5	I	Blue data (MSB)	
46	B4	I	Blue data	
47	B3	I	Blue data	
48	B2	I	Blue data	
49	B1	I	Blue data	
50	B0	I	Blue data (LSB)	
51	R/L	I	Right/ left selection	Note 1,2
52	V1	I	Gamma voltage level 1	
53	V4	I	Gamma voltage level 4	
54	V7	I	Gamma voltage level 7	
55	V10	I	Gamma voltage level 10	
56	V12	I	Gamma voltage level 12	
57	V13	I	Gamma voltage level 13	
58	AV _{DD}	P	Voltage for analog circuit	
59	GND	P	Power ground	
60	V _{COM}	I	Common voltage	

I: input, O: output, P: Power

Note 1: Selection of scanning mode

Setting of scan control input		IN/OUT state for start pulse				Scanning direction
U/D	R/L	STVD	STVU	STHR	STHL	
GND	V _{CC}	O	I	I	O	Up to down, left to right
V _{CC}	GND	I	O	O	I	Down to up, right to left
GND	GND	O	I	O	I	Up to down, right to left
V _{CC}	V _{CC}	I	O	I	O	Down to up, left to right

Note 2: Definition of scanning direction.

Refer to the figure as below:

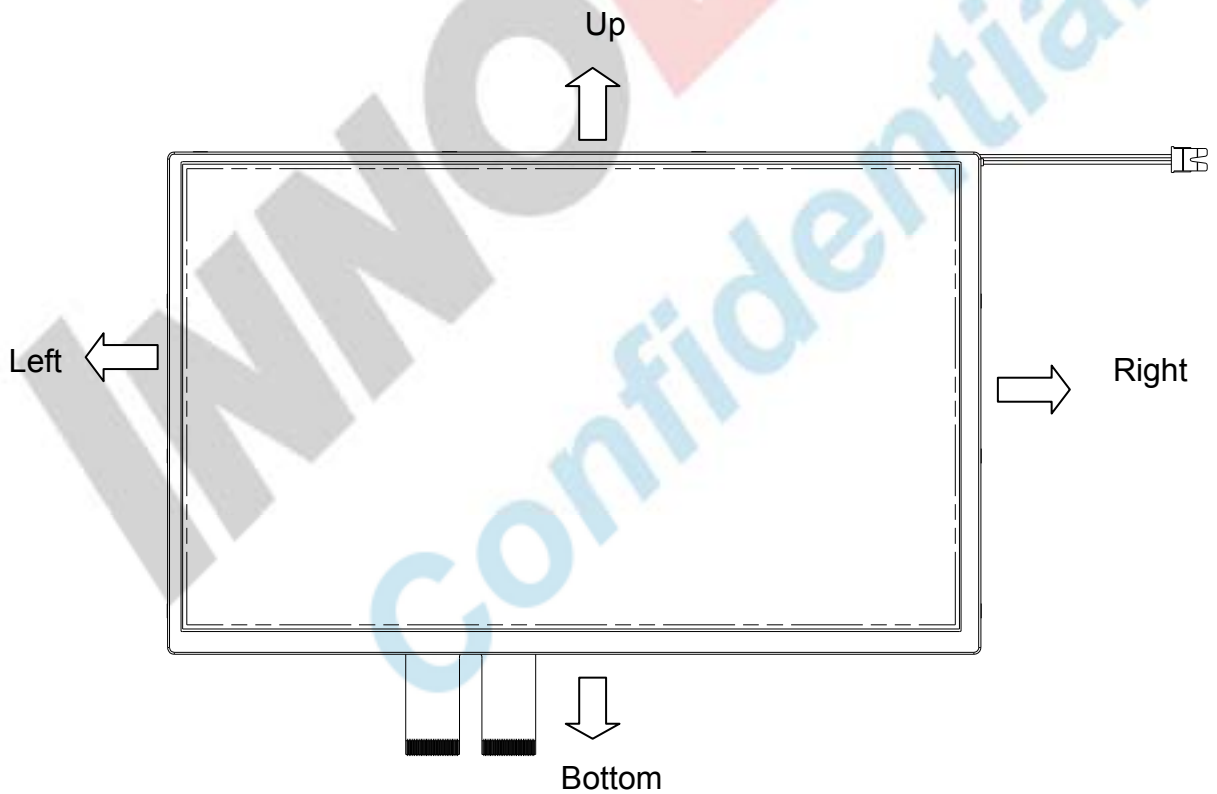

Note 3: When REV="L", normally REV="H", these data will be inverted.

2.2. Backlight Unit Section

LED Light Bar connector is used for the the integral backlight system. The recommended model is "BHSR-02VS-1" manufactured by JST.

Pin No.	Symbol	I/O	Function	Remark
1	V _{LED+}	P	Power for LED backlight anode	Pink
2	V _{LED-}	P	Power for LED backlight cathode	Black

3. Operation Specifications

3.1. Absolute Maximum Rating

(GND=AV_{SS}=0V, Note 2)

Item	Symbol	Values		Unit	Remark
		Min.	Max.		
Power voltage	V _{CC}	-0.3	5	V	
	AV _{DD}	-0.5	12	V	
	V _{GH}	-0.3	18	V	
	V _{GL}	-15	0.3	V	
	V _{GH} -V _{GL}	-	33	V	
Input signal voltage	V1~V7	0.4 AV _{DD}	AV _{DD} -0.1	V	Note 1
	V8~V14	-0.3	0.6AV _{DD}	V	
Operation temperature	T _{OP}	-30	85	°C	
Storage temperature	T _{ST}	-30	85	°C	
LED Reverse Voltage	V _r	-	1.2	V	Each LED Note 3
LED Forward Current	I _f	-	25	mA	Each LED

Note 1: AV_{DD} - 0.1 ≥ V1 ≥ V2 ≥ V3 ≥ V4 ≥ V5 ≥ V6 ≥ V7 ≥ V8 ≥ V9 ≥ V10 > V11 ≥ V12 ≥ V13 ≥ V14 ≥ AV_{SS} + 0.1

Note 2: The absolute maximum rating values of the module should not be exceeded. Once exceeded absolute maximum rating values, the characteristics of the module may not be recovered. Even in an extreme condition, may result in module permanently destroyed.

Note 3: V_r conditions: Zener Diode 20mA.

3.1.1 Typical Operation Conditions

(GND=AV_{SS}=0V, Note 1)

Item	Symbol	Values			Unit	Remark
		Min.	Typ.	Max.		
Power voltage	V _{CC}	3.0	3.3	3.6	V	
	AV _{DD}	9.0	9.2	9.4	V	
	V _{GH}	14.3	15.0	15.7	V	
	V _{GL}	-10.5	-10.0	-9.5	V	
Input signal voltage	V _{COM}	3.6	3.8	4.0	V	(V1+V14)/2 =4.9V
	V1~V7	0.4 AV _{DD}	-	AV _{DD} -0.1	V	
	V8~V14	0.1	-	0.6 AV _{DD}	V	
Input logic high voltage	V _{IH}	0.7V _{CC}	-	V _{CC}	V	
Input logic low voltage	V _{IL}	0	-	0.3V _{CC}	V	

Note 1: Be sure to apply GND, V_{CC}, and V_{GL}, to the LCD first, and then apply V_{GH}.

3.1.2 Current Consumption

(GND=AV_{SS}=0V)

Item	Symbol	Values			Unit	Remark
		Min.	Typ.	Max.		
Current for Driver	I _{GH}	-	0.3	0.5	mA	V _{GH} =15V
	I _{GL}	-	0.2	1.0	mA	V _{GL} = -10V
	I _{CC}	-	4	10	mA	V _{CC} =3.3V
	I _{AV_{DD}}	-	25	50	mA	AV _{DD} =9.2V

3.1.3 Backlight Driving Conditions

Item	Symbol	Values			Unit	Remark
		Min.	Typ.	Max.		
LED forward voltage	V _L	8.4	9.3	10.5	V	Note 1
LED forward current	I _L	180	200	220	mA	
LED life time	-	20,000	-	-	Hr	Note 2

Note 1: The LED Supply Voltage is defined by the number of LED at Ta=25°C and I_L =200mA.

Note 2: The “LED life time” is defined as the module brightness decrease to 50% original brightness at Ta=25°C and I_L =200mA. The LED lifetime could be decreased if operating I_L is larger than 200 mA.

3.2 Power Sequence

3.2.1 Power on:

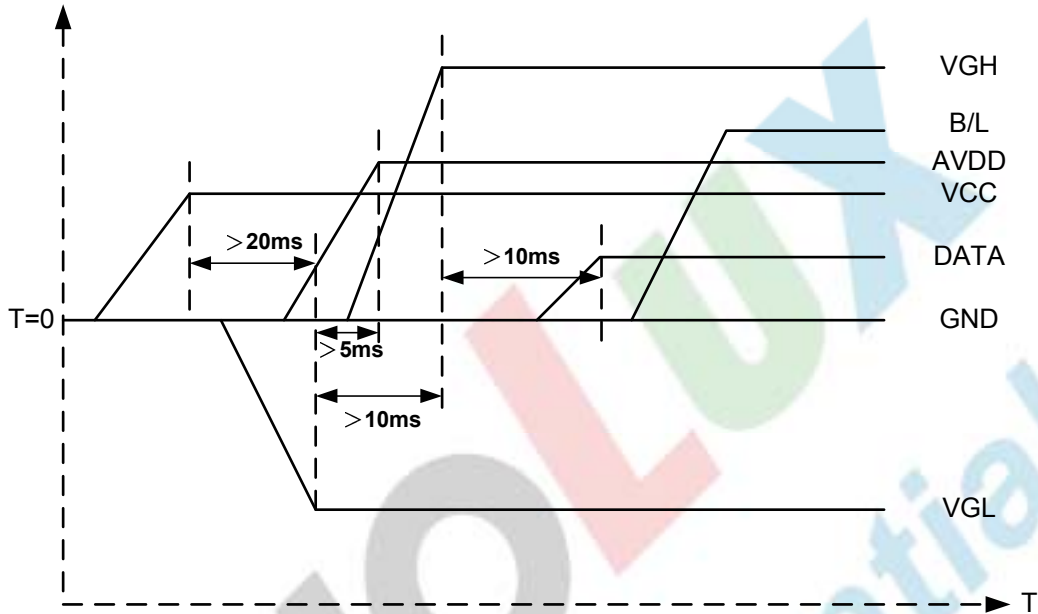

VCC→VGL→VGH→Data→B/L

3.2.2 Power off:

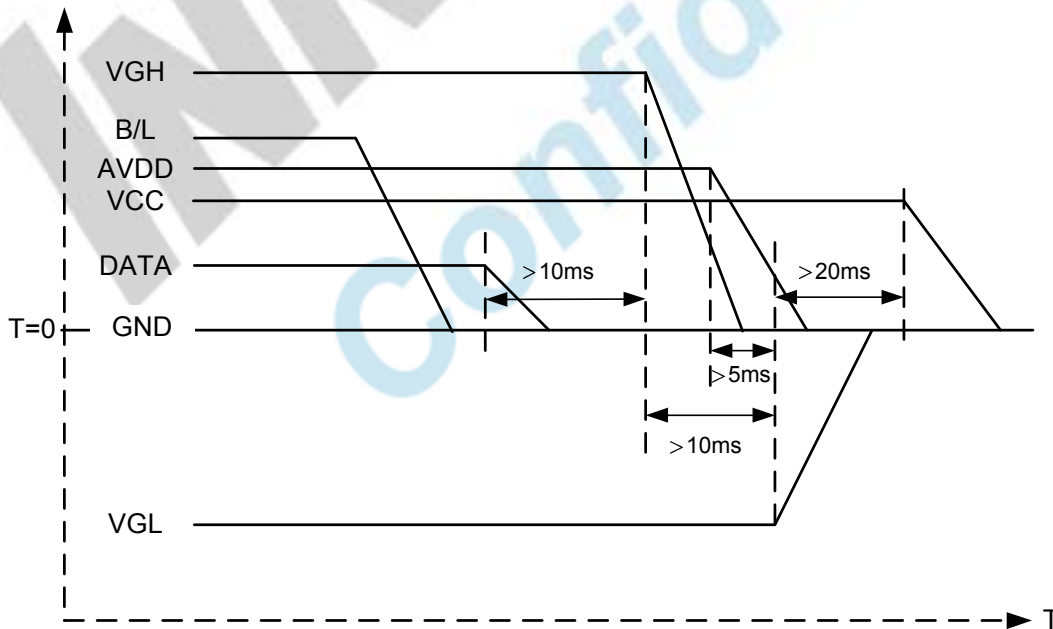

B/L→Data→VGH→VGL→VCC

Note: Data includes POL, STVD, OEV, CKV, STVU, EDGSL, STHL, REV, DCLK, V_{CC}, STHR, LD.

版權屬於群創所有，禁止任何未經授權的使用

3.3 Timing Characteristics

3.3.1 Timing Conditions

Item	Symbol	Values			Unit	Remark
		Min.	Typ.	Max.		
DCLK frequency	F_{dclk}	-	40	45	MHz	
DCLK cycle	T_{cph}	22	25	-	ns	
DCLK pulse width	T_{cw}	8	-	-	ns	
Data set-up time	T_{su}	4	-	-	ns	
Data hold time	T_{hd}	2	-	-	ns	
Time that the last data to LD	T_{ld}	1	-	-	Tcph	
Pulse width of LD	T_{wid}	2	-	-	Tcph	
Time that LD to STHL/R	T_{lds}	5	-	-	Tcph	
POL set-up time	T_{psu}	6	-	-	ns	
POL hold time	T_{phd}	6	-	-	ns	
CKV frequency	F_{vclk}	-	-	200	KHz	
CKV rise time	T_{rck}	-	-	100	ns	
CKV falling time	T_{fck}	-	-	100	ns	
CKV pulse width	P_{WCLK}	500	-	-	ns	
Horizontal display timing range	T_{dh}	-	800	-	Tcph	
Horizontal timing range	T_h	-	1056	-	Tcph	
STVU/D setup time	T_{suv}	200	-	-	ns	
STVU/D hold time	T_{hdv}	300	-	-	ns	
STVU/D delay time	T_{dt}	-	-	500	ns	
Driver output delay time	T_{do}	-	-	900	ns	
Output rise time	T_{th}	-	500	1000	ns	
Output falling time	T_{thl}	-	400	800	ns	
OEV pulse width	T_{wcl}	1	-	-	us	
OEV to Driver output delay time	T_{oe}	-	-	900	ns	
Horizontal lines per field	T_v	512	525	610	Line	
Vertical display timing range	T_{vd}	-	480	-	Line	

版權屬於群創所有，禁止任何未經授權的使用

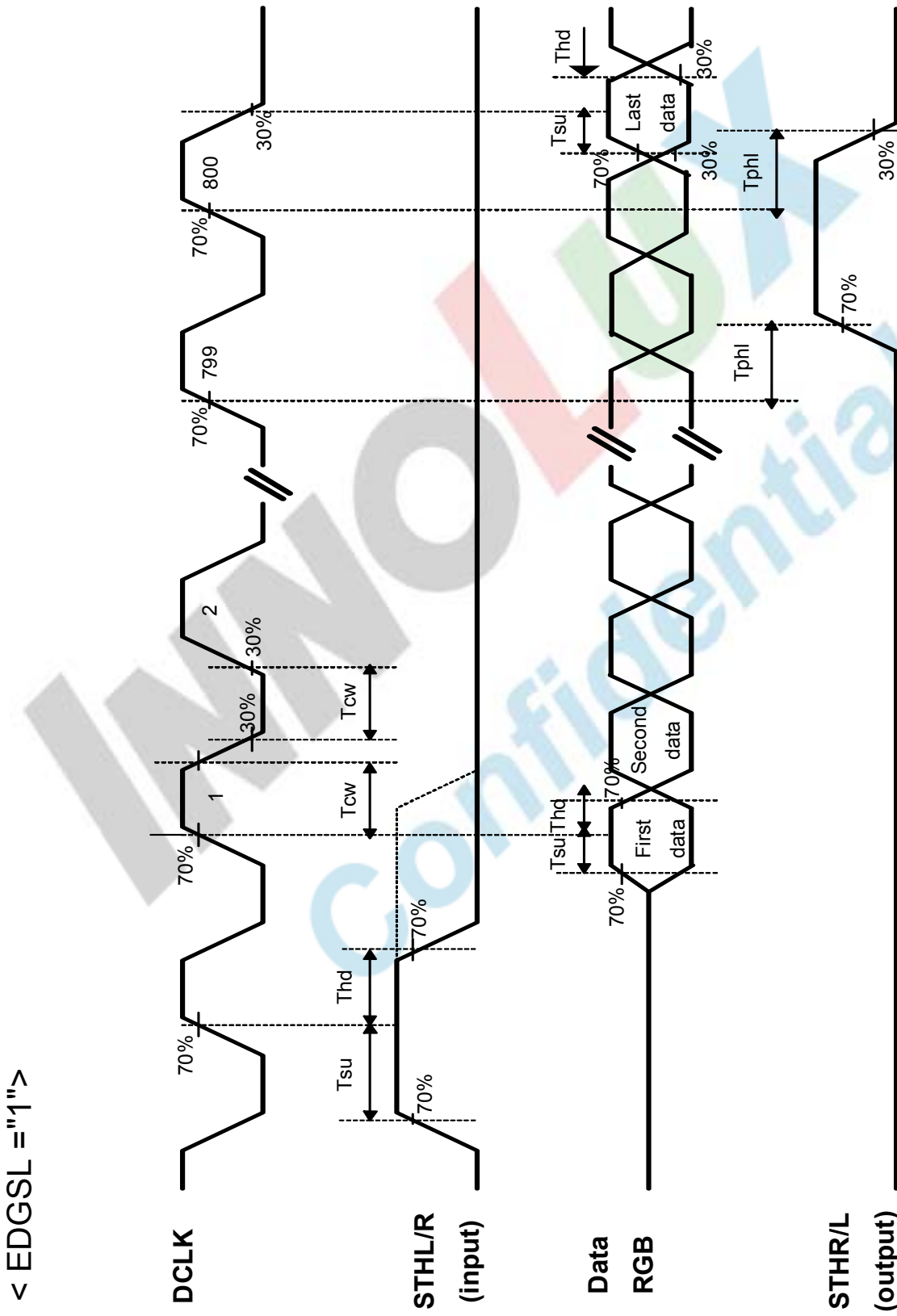

Fig.3-2 operation model 2

版權屬於群創所有, 禁止任何未經授權的使用

Timing Diagram 2

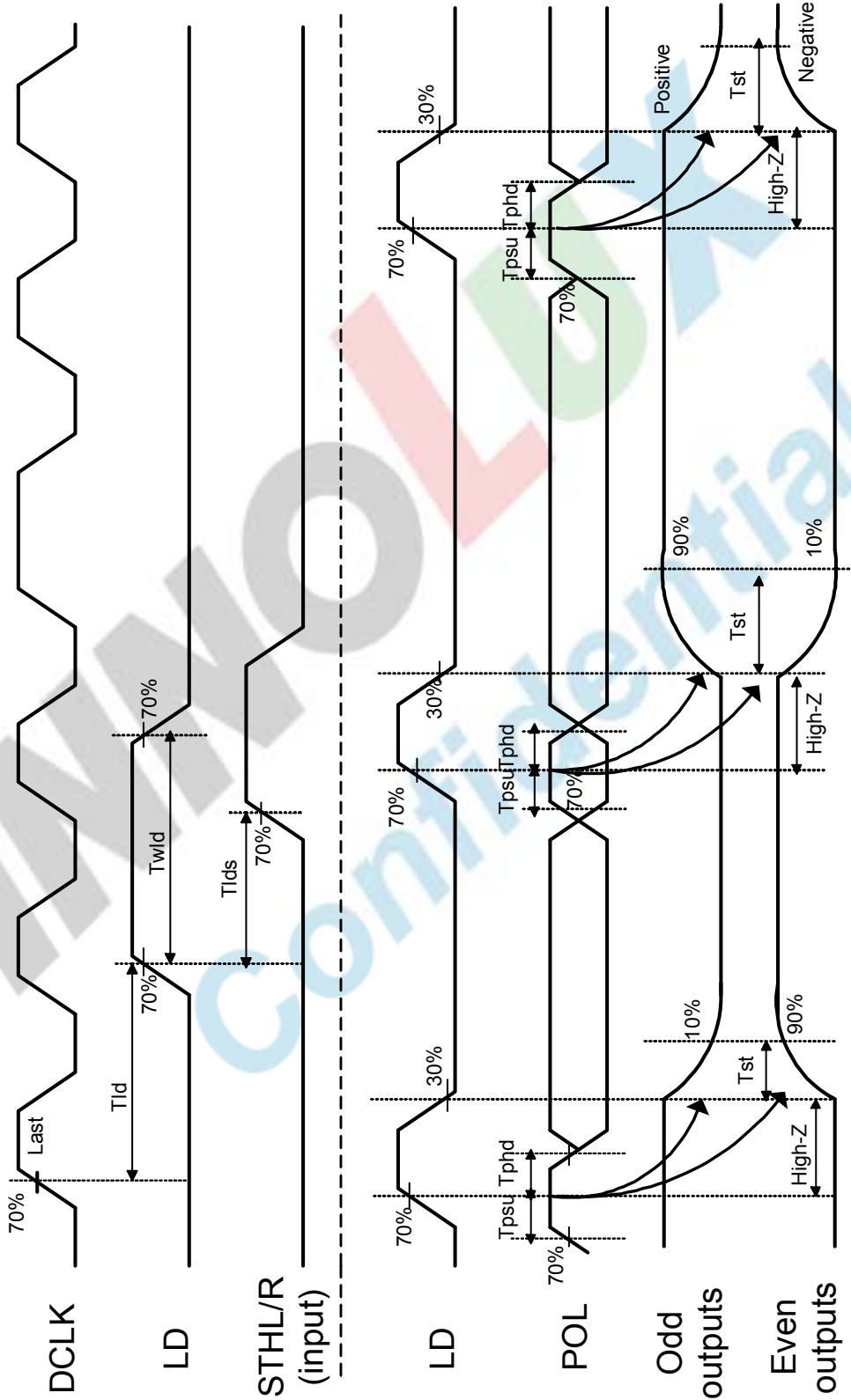

Fig.3-3 Horizontal timing 1

版權屬於群創所有, 禁止任何未經授權的使用

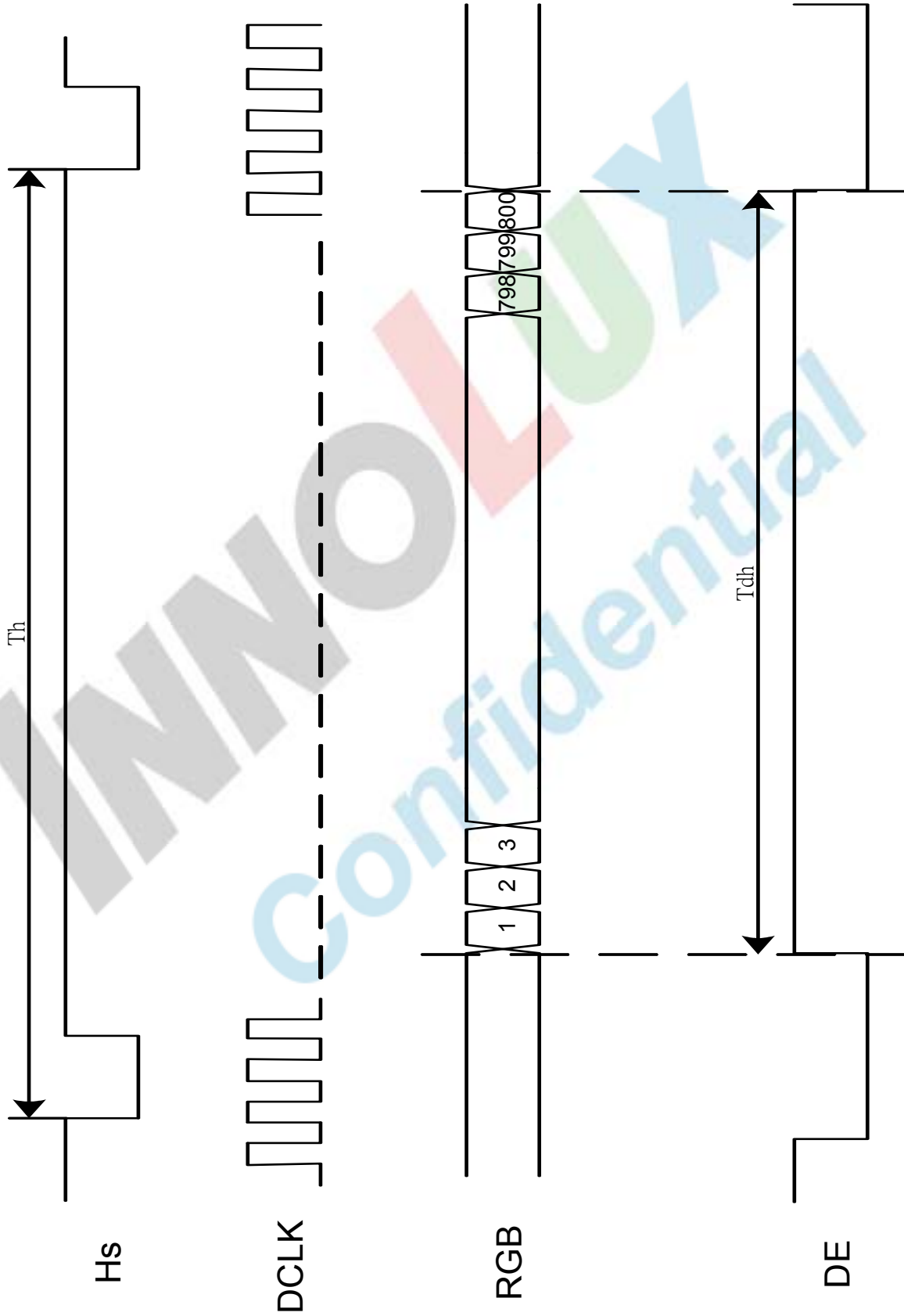

Fig.3-4 Horizontal timing 2

版權屬於群創所有, 禁止任何未經授權的使用

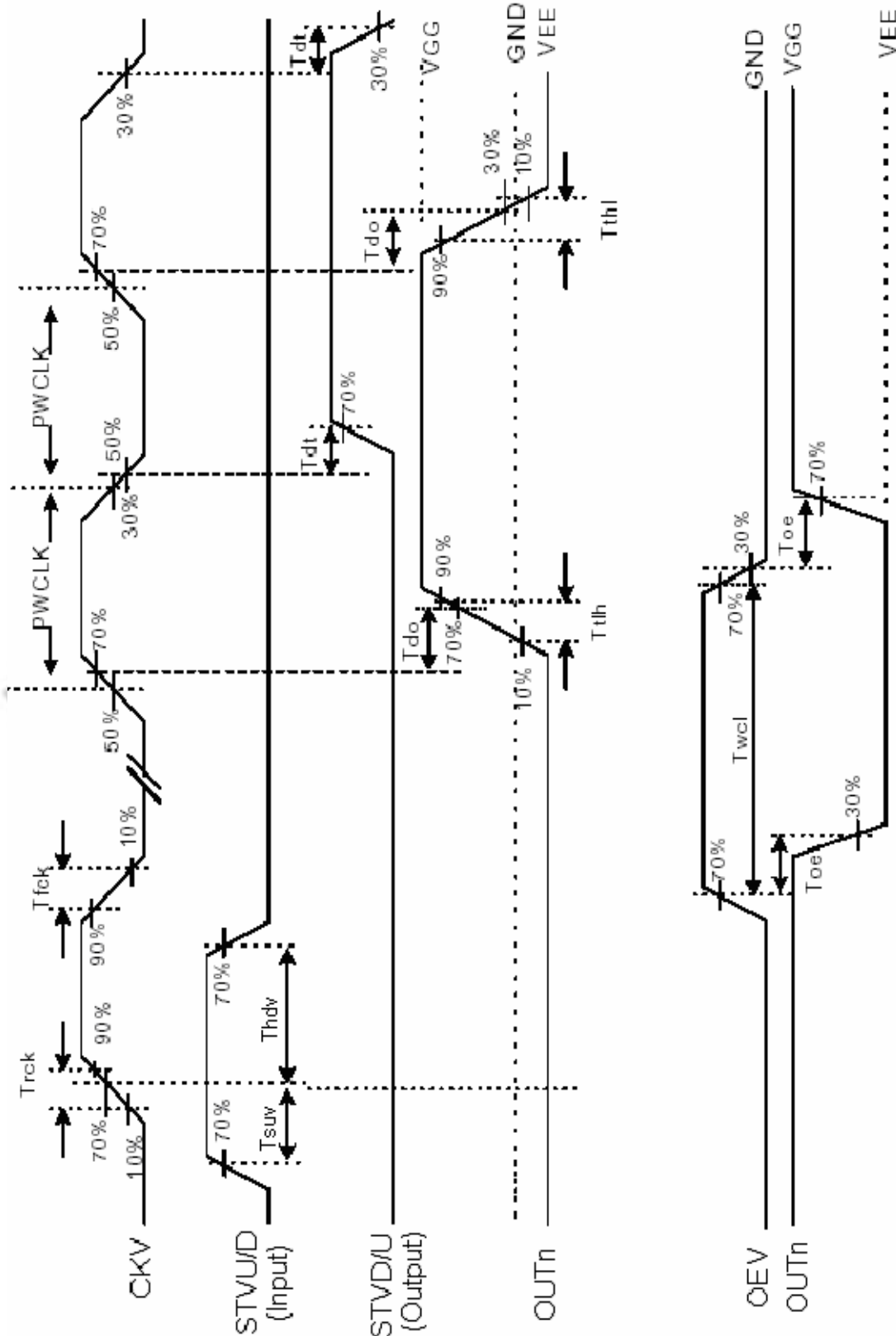

Fig.3-5 Vertical shift clock timing

版權屬於群創所有，禁止任何未經授權的使用

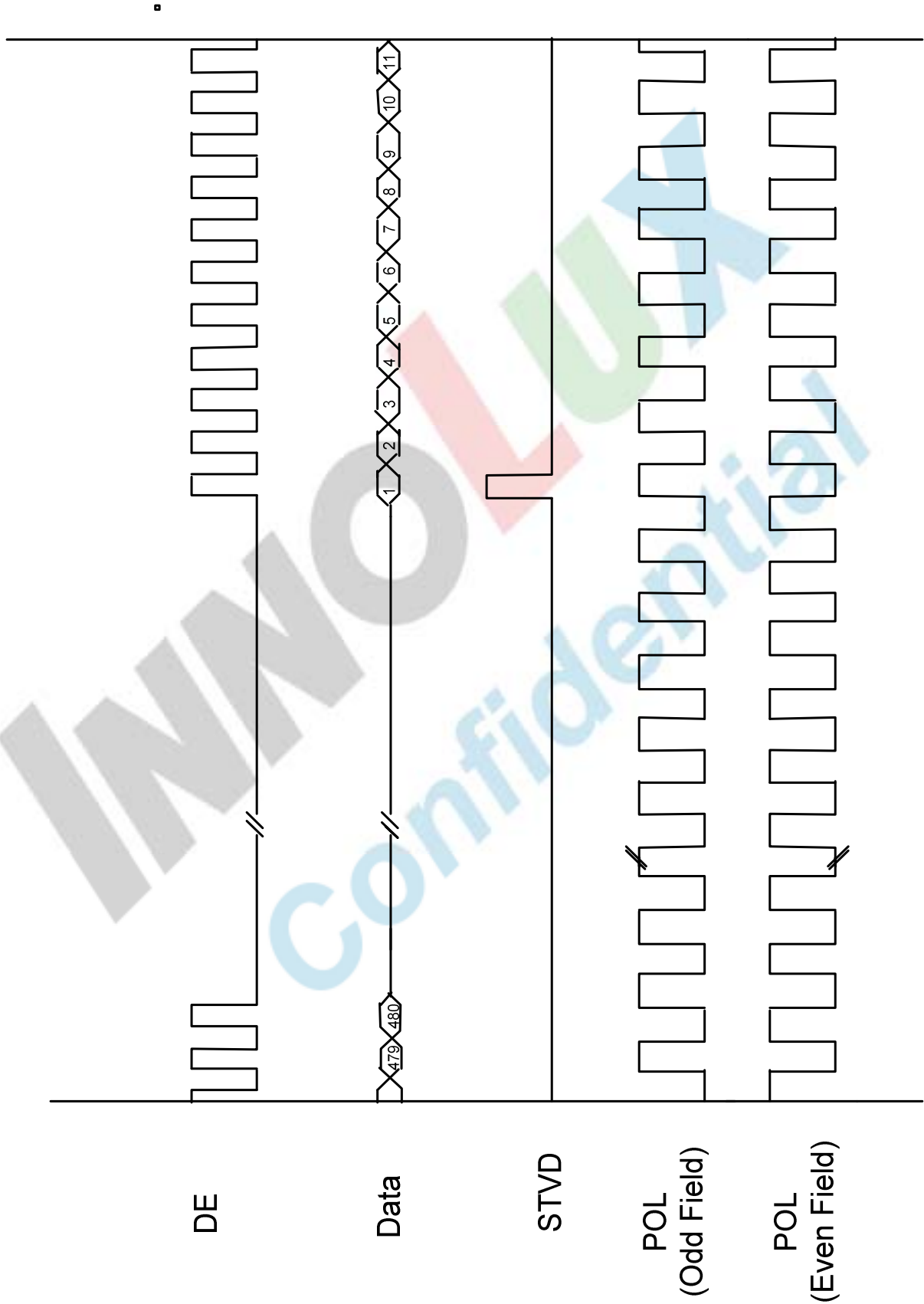

Fig.3-6 Vertical timing (from up to down)

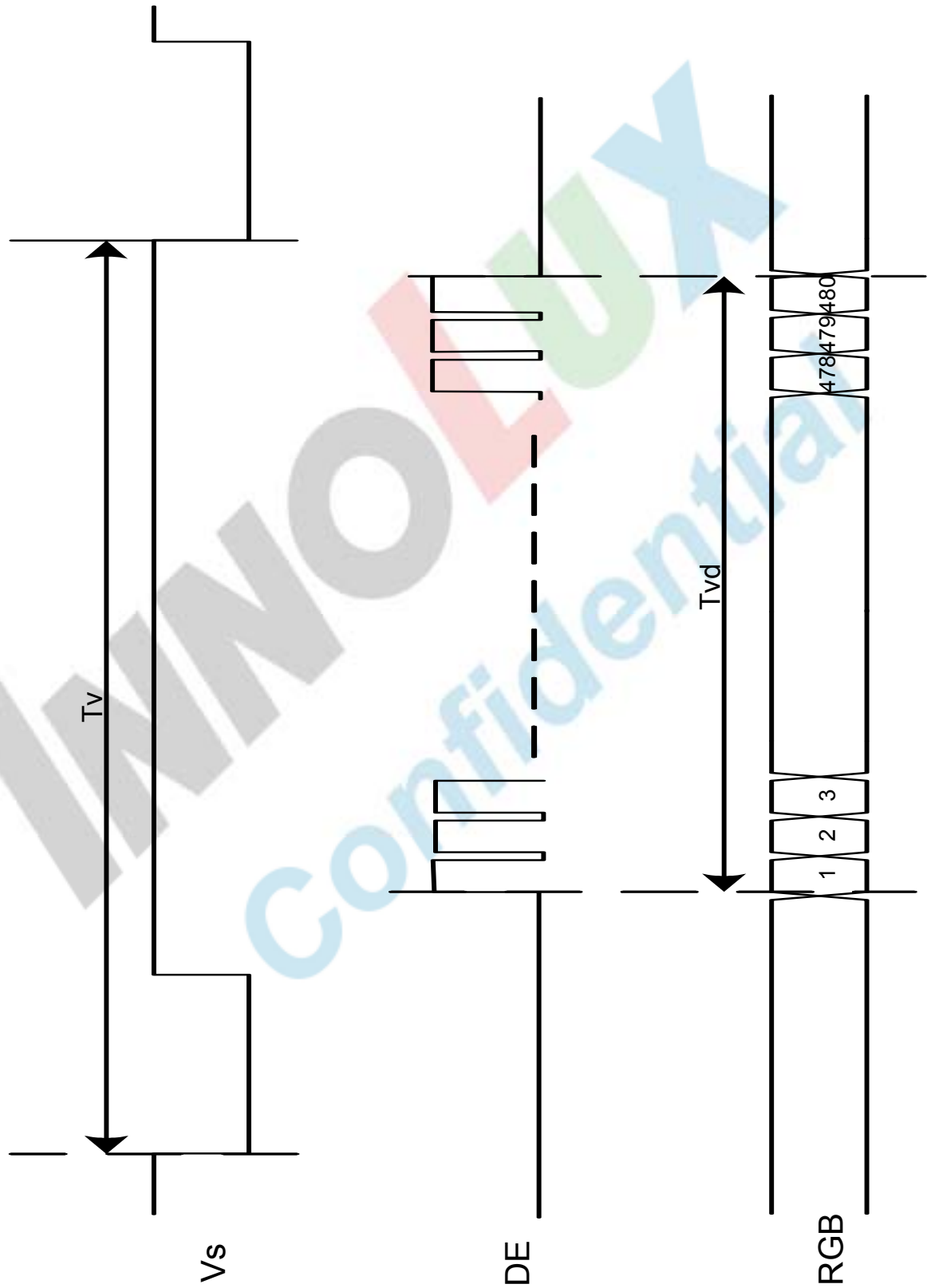

Fig.3-7 Vertical timina

版權屬於群創所有, 禁止任何未經授權的使用

4. Optical Specifications

Item	Symbol	Condition	Values			Unit	Remark
			Min.	Typ.	Max.		
Viewing angle (CR≥10)	θ_L	$\Phi=180^\circ$ (9 o'clock)	55	65	-	degree	Note 1
	θ_R	$\Phi=0^\circ$ (3 o'clock)	55	65	-		
	θ_T	$\Phi=90^\circ$ (12 o'clock)	35	45	-		
	θ_B	$\Phi=270^\circ$ (6 o'clock)	55	65	-		
Response time	T_{ON}	Normal $\theta=\Phi=0^\circ$	-	15	30	msec	Note 3
	T_{OFF}		-	20	40	msec	Note 3
Contrast ratio	CR		250	300	-	-	Note 4
Color chromaticity	W_X		0.26	0.31	0.36	-	Note 5
	W_Y		0.28	0.33	0.38	-	Note 6
Luminance	L		200	250	-	cd/m ²	Note 6
Luminance uniformity	Y_U		70	75	-	-	Note 7

Test Conditions:

1. $V_{CC}=3.3V$, $I_L=200mA$ (Backlight current), the ambient temperature is $25^\circ C$.
2. The test systems refer to Note 2.

Note 1: Definition of viewing angle range

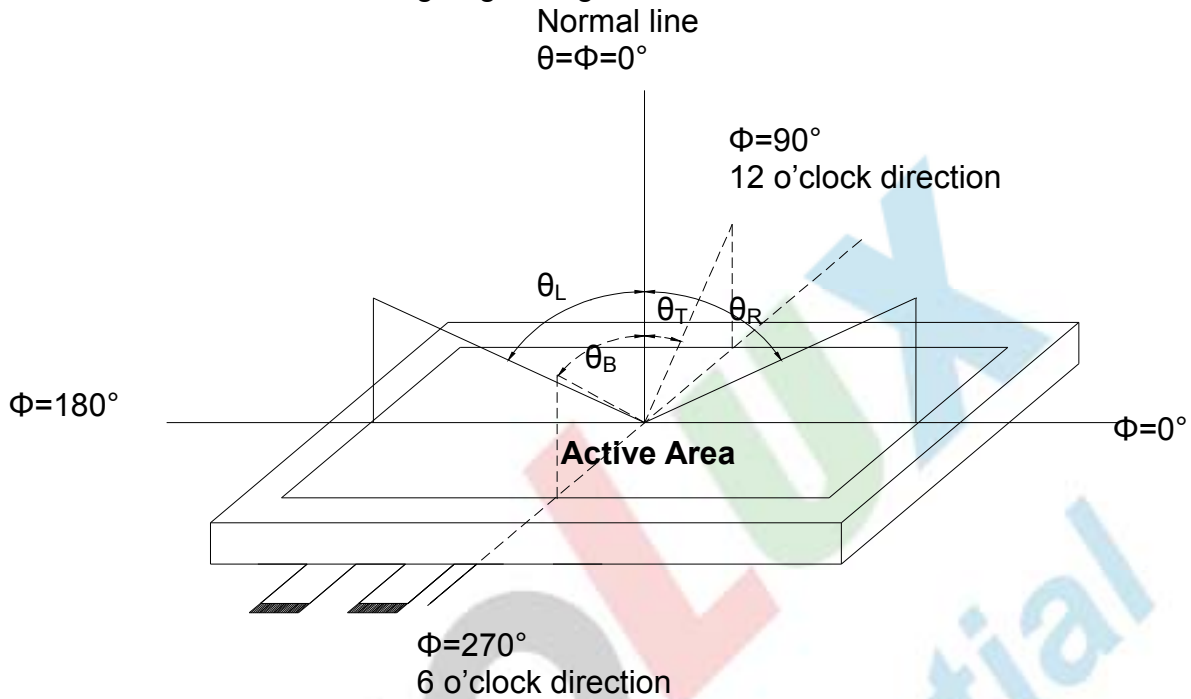

Fig. 4-1 Definition of viewing angle

Note 2: Definition of optical measurement system.

The optical characteristics should be measured in dark room. After 30 minutes operation, the optical properties are measured at the center point of the LCD screen. (Response time is measured by Photo detector TOPCON BM-7, other items are measured by BM-5A/Field of view: 1° /Height: 500mm.)

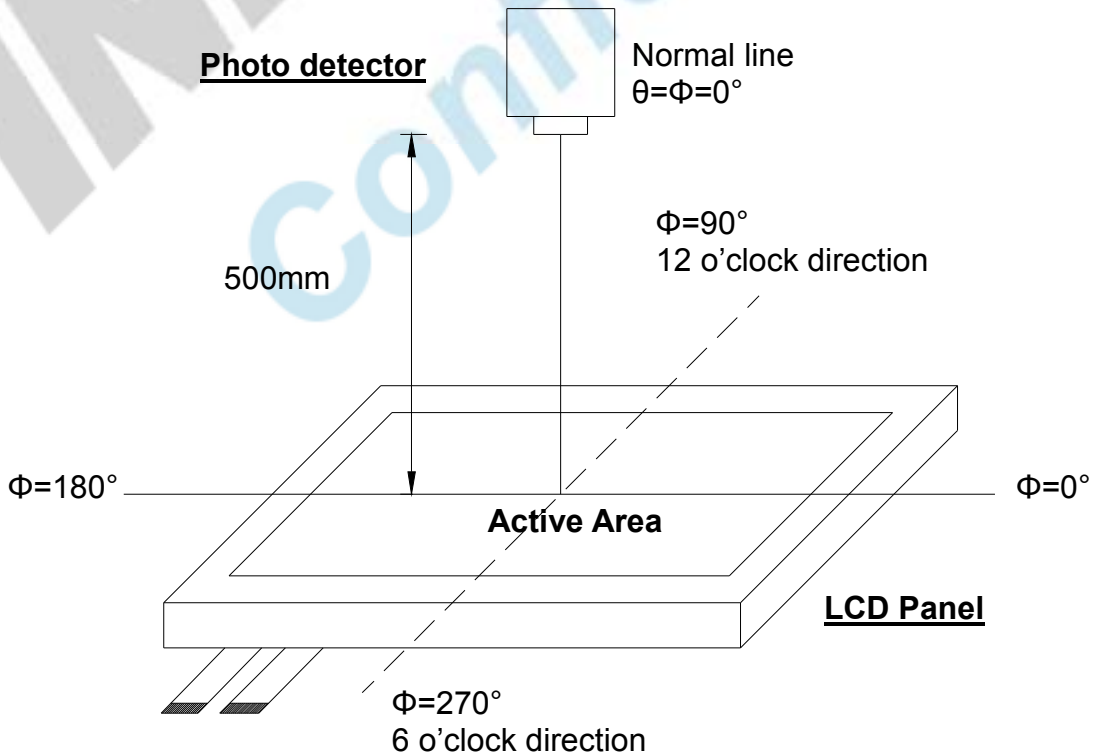

Fig. 4-2 Optical measurement system setup

Note 3: Definition of Response time

The response time is defined as the LCD optical switching time interval between "White" state and "Black" state. Rise time (T_{ON}) is the time between photo detector output intensity changed from 90% to 10%. And fall time (T_{OFF}) is the time between photo detector output intensity changed from 10% to 90%.

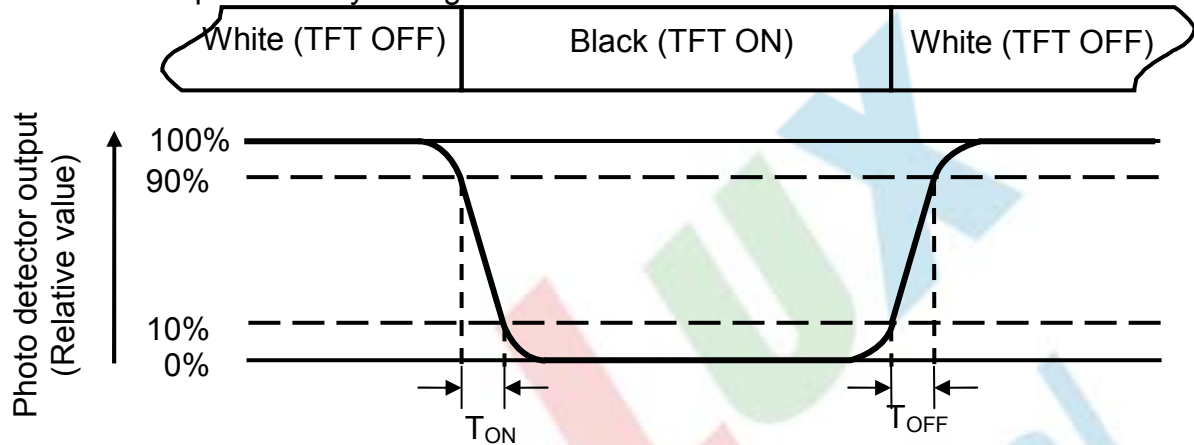

Fig. 4-3 Definition of response time

Note 4: Definition of contrast ratio

$$\text{Contrast ratio (CR)} = \frac{\text{Luminance measured when LCD on the "White" state}}{\text{Luminance measured when LCD on the "Black" state}}$$

Note 5: Definition of color chromaticity (CIE1931)

Color coordinates measured at center point of LCD.

Note 6: All input terminals LCD panel must be ground when measuring the center area of the panel. The LED driving condition is $I_L=200\text{mA}$.

Note 7: Definition of Luminance Uniformity

Active area is divided into 9 measuring areas (Refer to Fig. 4-4).Every measuring point is placed at the center of each measuring area.

$$\text{Luminance Uniformity (Yu)} = \frac{B_{min}}{B_{max}}$$

L-----Active area length W----- Active area width

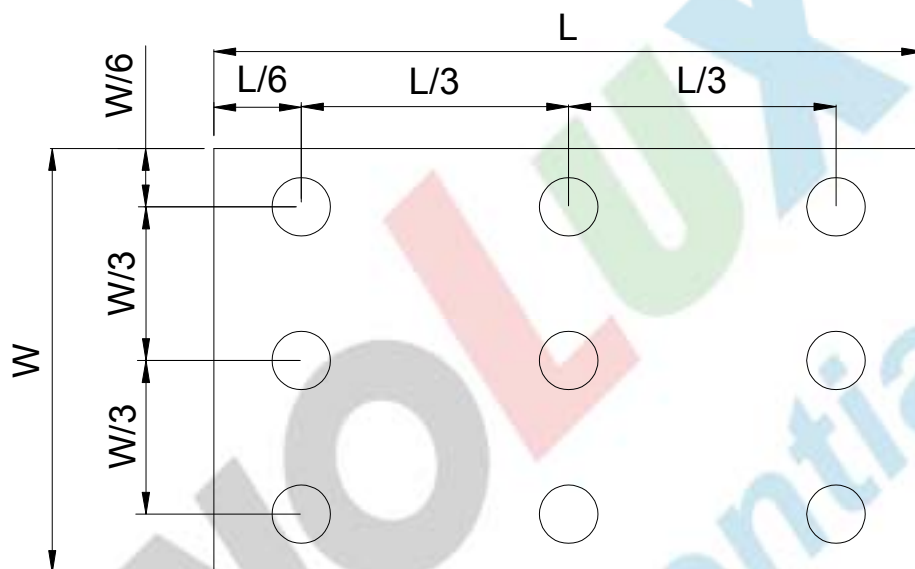

Fig. 4-4 Definition of measuring points

B_{max}: The measured maximum luminance of all measurement position.

B_{min}: The measured minimum luminance of all measurement position.

6. General Precautions

6.1 Safety

Liquid crystal is poisonous. Do not put it in your mouth. If liquid crystal touches your skin or clothes, wash it off immediately by using soap and water.

6.2 Handling

1. The LCD panel is plate glass. Do not subject the panel to mechanical shock or to excessive force on its surface.
2. The polarizer attached to the display is easily damaged. Please handle it carefully to avoid scratch or other damages.
3. To avoid contamination on the display surface, do not touch the module surface with bare hands.
4. Keep a space so that the LCD panels do not touch other components.
5. Put cover board such as acrylic board on the surface of LCD panel to protect panel from damages.
6. Transparent electrodes may be disconnected if you use the LCD panel under environmental conditions where the condensation of dew occurs.
7. Do not leave module in direct sunlight to avoid malfunction of the ICs.

6.3 Static Electricity

1. Be sure to ground module before turning on power or operating module.
2. Do not apply voltage which exceeds the absolute maximum rating value.

6.4 Storage

1. Store the module in a dark room where must keep at $+25\pm 10^{\circ}\text{C}$ and 65%RH or less.
2. Do not store the module in surroundings containing organic solvent or corrosive gas.
3. Store the module in an anti-electrostatic container or bag.

6.5 Cleaning

1. Do not wipe the polarizer with dry cloth. It might cause scratch.
2. Only use a soft sloth with IPA to wipe the polarizer, other chemicals might permanent damage to the polarizer.

7 Mechanical Drawing

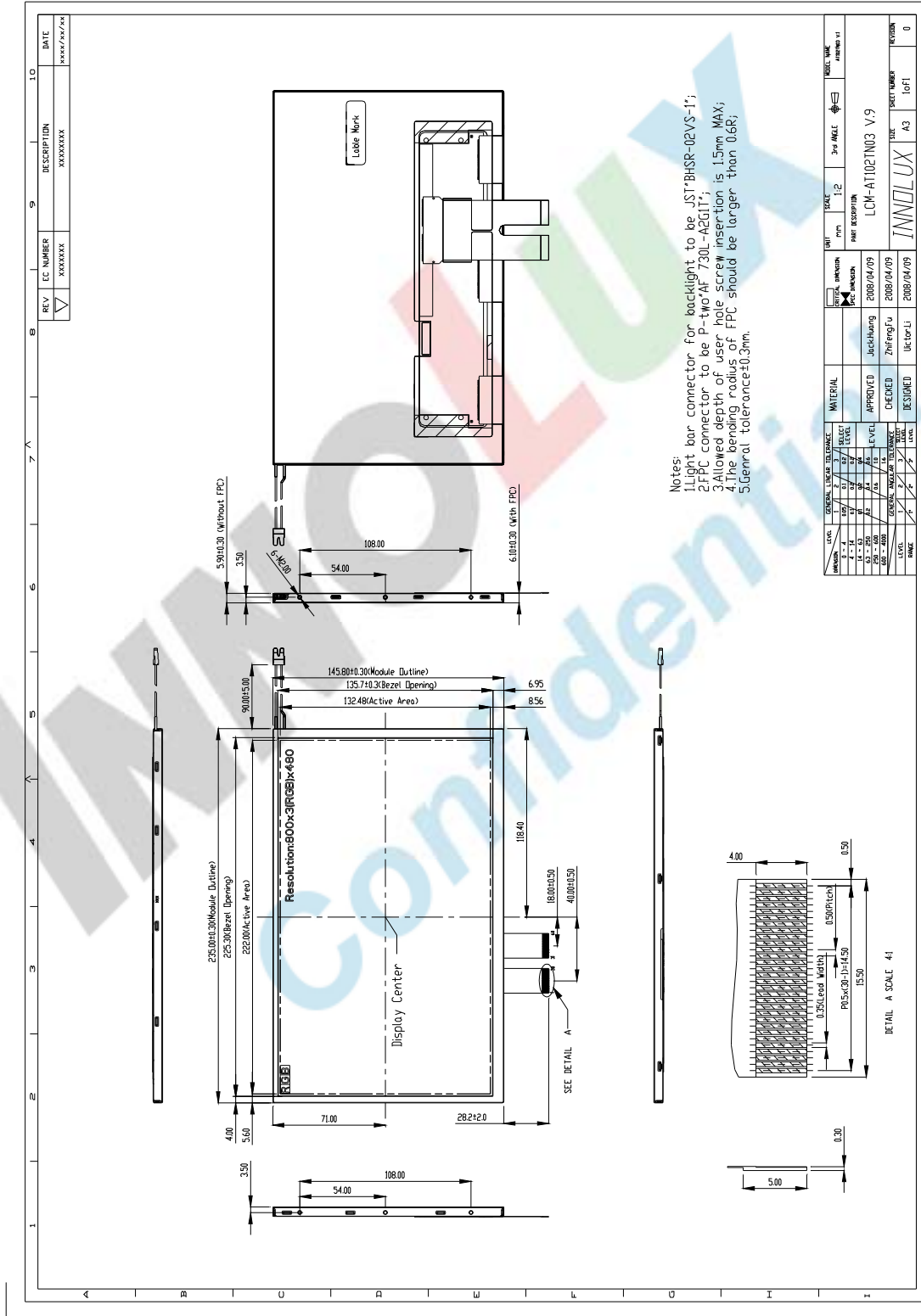

版權屬於群創所有，禁止任何未經授權的使用

8 Package Drawing

8.1 Packaging Material Table

No	Item	Model (Material)	Dimensions (mm)	Unit Weight (kg)	Quantity	Remark
1	LCM module	AT102TN03 V.9	235 × 145.8 × 6.1	TBD	25pcs	
2	Partition	BC Corrugated paper	512 × 349 × 226	1.154	1 set	
3	Corrugated Bar	B Corrugated paper	512 × 370 × 7	0.220	2 pcs	
4	Dust-Proof Bag	PE	900 × 700 × 0.05	0.010	1 pcs	
5	A/S Bag	PE	256 × 203 × 0.07	0.010	25 pcs	$10^9 \sim 10^{11} \Omega/\text{sq}$
6	Carton	Corrugated paper	530 × 355 × 255	0.810	1 pcs	
7	Total weight	TBD				

8.2 Packaging Quantity

Total LCM quantity in Carton: no. of Partition	1 Rows x quantity per Row	25	= 25
--	---------------------------	----	------

8.3 Packaging Drawing

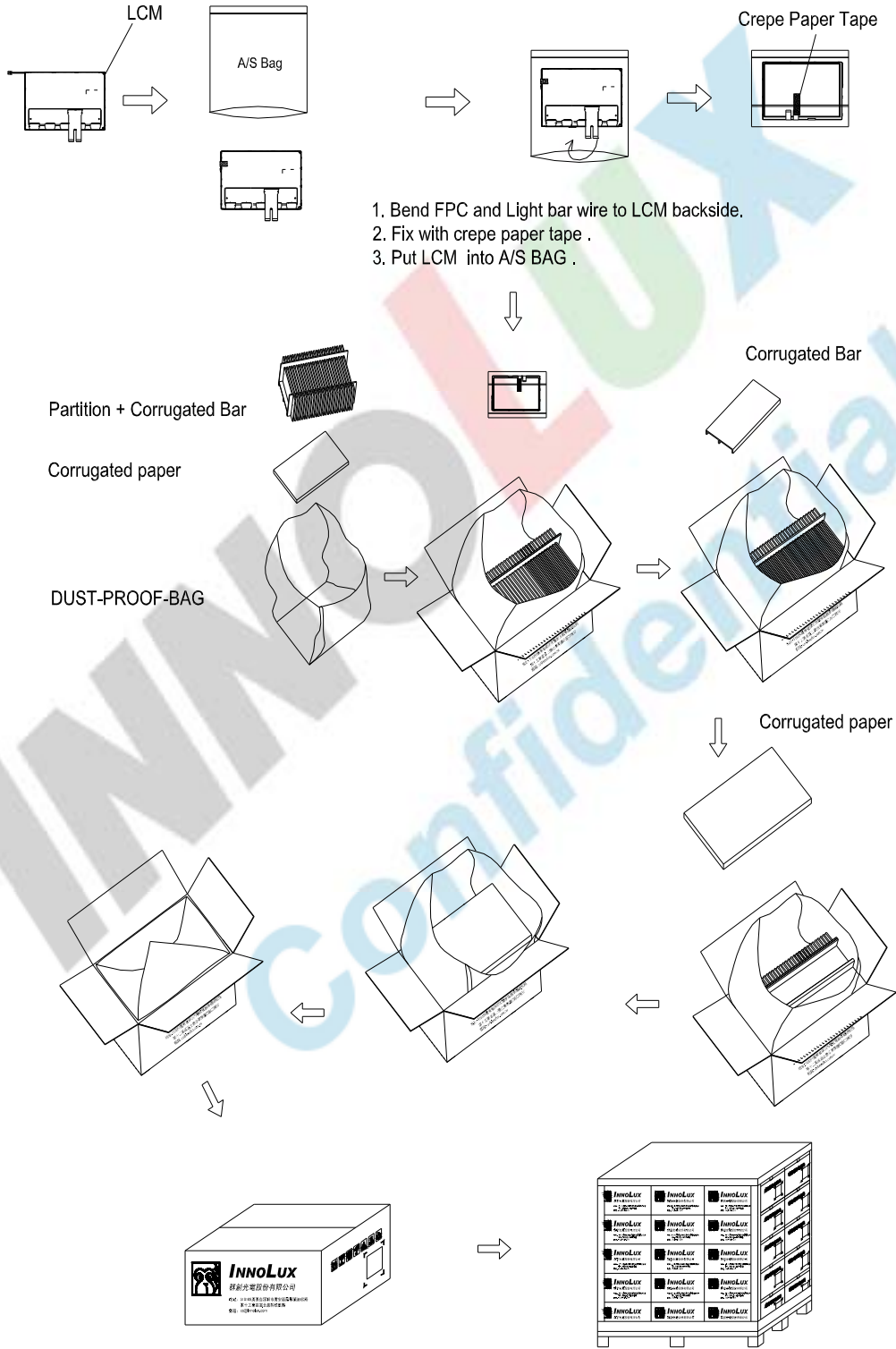

版權屬於群創所有, 禁止任何未經授權的使用